

Laser Facsimile

User's Guide

SF-5100

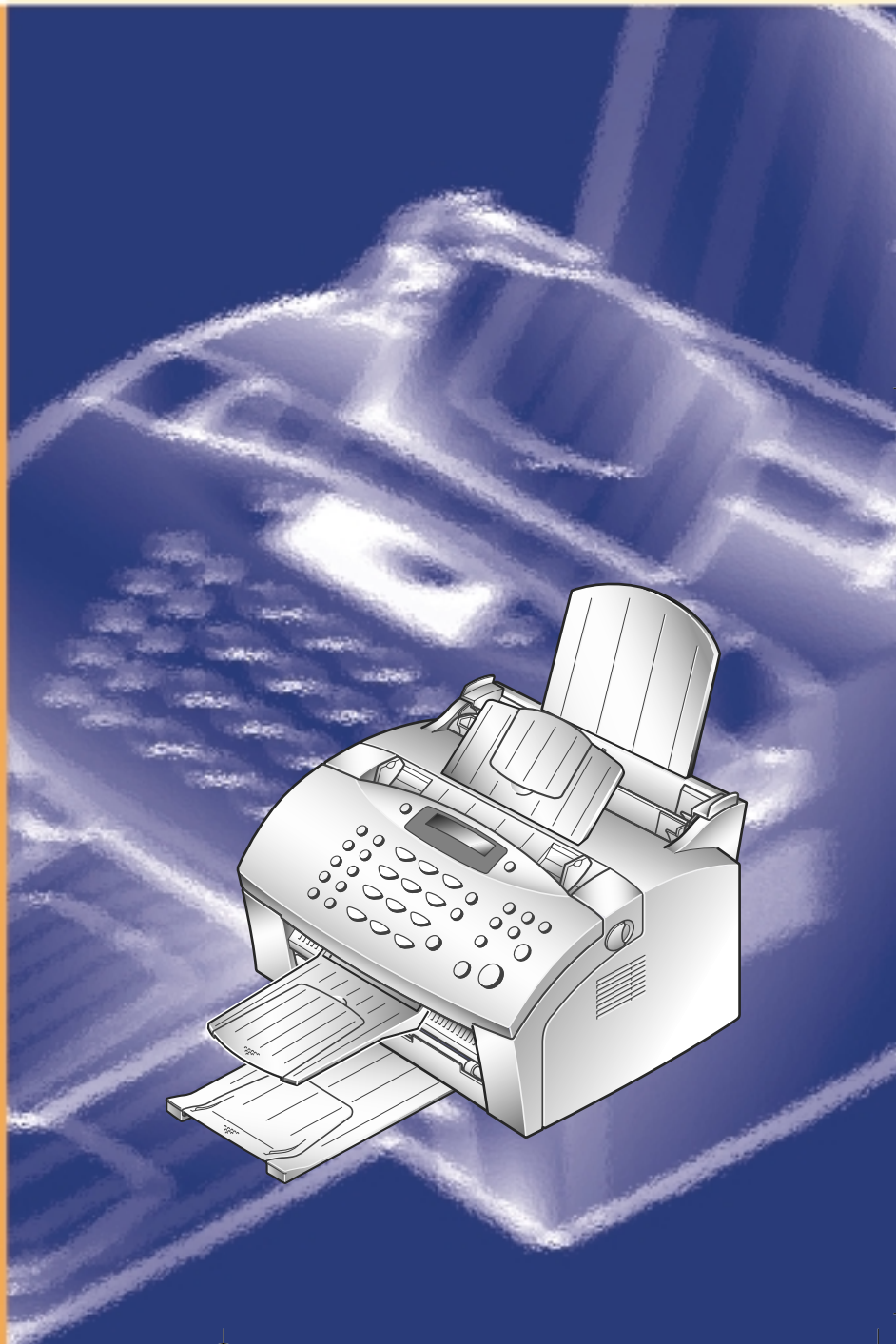

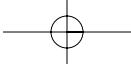

Trademark Notices

- SF-5100 and Samsung Logo are trademarks of Samsung Electronics Co., Ltd.
- IBM is a trademark of international Business Machines.
- Other name and the trademarks mentioned in this manual are trademarks of their respective holders.

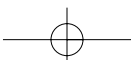

Contents

Chapter 1 Installation

Unpacking	1.1
Control locations and functions	1.2
Choosing a location	1.4
Setting up your machine	1.4
Document tray	1.4
Paper exit tray	1.4
Document exit tray	1.5
Handset and handset cradle	1.5
Telephone line	1.6
Extension phone (optional)	1.7
AC power cord	1.7
Installing the toner cartridge	1.8
Loading paper	1.10
Paper type and size	1.12
Printing a demo page	1.13

Chapter 2 Getting started

Using the control panel	2.1
Using the number keypad	2.3
Setting up your fax number and name	2.6
Setting the time and date	2.7
Adjusting volume	2.8

Chapter 3 Basic operation

Sending a fax

Preparing documents for faxing or copying	3.1
Setting document resolution and contrast	3.2
Loading document	3.3
Sending a fax automatically	3.4
Sending a fax after talking	3.4
Voice request	3.5

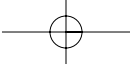
**Receiving a fax**

Receiving a fax _____	3.6
Receiving automatically in FAX mode _____	3.7
Receiving manually in TEL mode _____	3.7
Receiving in AUTO mode _____	3.8
Receiving automatically in ANS/FAX mode _____	3.8
Receiving manually using an extension telephone _____	3.9

Making a copy

Copying overview _____	3.10
Making a simple copy _____	3.10
Advanced copy features _____	3.11

Other functions

Redial _____	3.12
Sending a recall _____	3.13
Monitoring a dual job status _____	3.13

Automatic dialing

One-touch dialing _____	3.14
Speed dialing _____	3.16
Searching for a number in the memory _____	3.18

Chapter 4**Advanced fax**

Broadcasting _____	4.1
Delayed fax _____	4.2
Priority fax _____	4.4
Polling _____	4.5
Adding documents to a scheduled operation _____	4.7
Canceling a scheduled operation _____	4.7

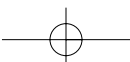

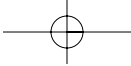

Chapter 5 Additional features

Printing reports _____	5.1
System setup _____	5.2
Group dialing _____	5.7
Clearing memory _____	5.9

Chapter 6 Troubleshooting

Troubleshooting

Clearing jams _____	6.1
LCD error messages _____	6.5
Fixing problems _____	6.7

Maintenance

Cleaning the OPC drum _____	6.9
Adjusting shading _____	6.10
Setting the machine to be checked by phone _____	6.10
Sending toner low information to the service company ____	6.11
Cleaning the document scanner _____	6.11
Managing the toner cartridge _____	6.14

Appendix

FCC regulations _____	7.1
Canadian radio interference regulations _____	7.1
FCC DECLARATION OF CONFORMITY _____	7.2
Laser safety statement _____	7.3
Safety information _____	7.4
Power saver _____	7.5
Specifications _____	7.6
Index _____	7.7

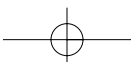

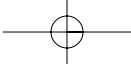

Important safety information



Always be careful when using the machine. To reduce the risk of fire, electrical shock, and other injuries, keep these safety considerations in mind when installing, using, and maintaining your machine:

- **Stability.** Place the machine on a secure, stable surface. The machine can be seriously damaged if it falls.
- **Power supply.** Provide correct power to the machine, as listed on the back of the machine. If you are not sure of the type of power that is supplied to your home or office, call your electric company.
- **Grounding.** If the plug has three prongs, it must be plugged into a grounded (three hole) outlet. Grounded plugs and outlets are designed for your safety – do not try to make a three-prong plug fit into a two-prong outlet by modifying the plug or outlet in any way. If you cannot insert the plug into your wall outlet easily, the outlet should be inspected by a qualified electrician.
- **Overload.** Do not plug too many electrical devices into a wall outlet or an extension cord. An overloaded outlet is a fire and electrical shock hazard.
- **Cleaning.** Before cleaning the machine, unplug it from both the power outlet and the telephone jack. Clean exposed parts with a soft cloth slightly dampened with water. Do not use aerosol cleaners.
- **Thunderstorms.** Unplug electrical appliances during thunderstorms. Avoid using any telephone (except a cordless model) during a thunderstorm, since there is a small chance you could get an electrical shock from lightning.
- **Gas leaks.** Never use any telephone close to a gas leak. If you think gas is leaking, call the gas company immediately, but use a telephone that is far away from the leakage area. A small electrical spark in the telephone could cause a fire or explosion.
- **Ozone.** This product produces ozone during normal operation. The ozone produced is dependent on copy volume and is heavier than air. If your machine is installed as specified in the installation procedures, ozone output levels meet safe limits.

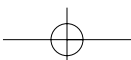

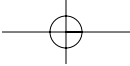

Precautions

When using your machine, these precautions should always be followed.

1. Never push objects of any kind into your machine through the case or cabinet openings. They may touch dangerous voltage points, creating a risk fire or shock. Never spill liquid of any kind onto or into the machine.
2. Slots and openings in the back and sides of your machine's cabinet are provided for ventilation. To ensure a reliable operation of the machine and to protect it from overheating, these openings must not be blocked or covered. Your machine should never be placed on, near, or over a radiator, heater, air conditioner, or ventilation duct.
3. Do not use your machine near water, in wet locations, or outdoors.
4. Do not allow anything to rest on the power cord or line cord.
Do not locate your fax machine where the cords will be damaged by persons walking on them.
5. Do not allow pets to chew on the power cord or line cord.
6. Do not put your hands into the fuser area. The fuser is extremely hot and severe burns can result from the contact. Do not put your hands into the scanner motor, scanner bracket and scanner motor cover, either.
7. Always use materials specially designed for your machine. Use of other materials may result in poor performance and could create a hazardous situation.
8. Use supplies or cleaning materials only as directed. Keep all supplies and materials out of the way of children.
9. The power supply turns this machine on and off. Make sure that your machine is installed near an outlet and is easily accessible.
10. Your machine is equipped with an energy saving device to conserve power when the machine is not in use. The machine may be left on continuously.
11. Never remove covers or guards that require a tool for removal. There are no operator serviceable areas inside your machine. Refer servicing to authorized service personnel.
12. Never defeat interlock switches. This machine is designed to restrict operator access to unsafe areas. Covers, guards and interlock switches are provided to ensure that the machine will not operate with covers opened.
13. Use of an extension cord with this machine is not recommended or authorized.
14. Avoid direct viewing of the document lights. The lamps are bright and, while not harmful, they may cause an annoying afterimage. Always keep the document cover closed during operation and storage.
15. Avoid exposing the toner cartridge to light for extended periods of time.
16. Do not touch the green photoreceptor. Scratches or smudges that appear on the photoreceptor will result in poor copy quality and may shorten the service life.
17. This equipment is not designed for making telephone calls when the power fails. Alternative equipment should be made available for access to emergency services.

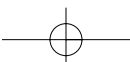

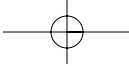

Safety notes

Your machine and the supplies are designed and tested to meet strict safety requirements. Included are safety agency examination and approval and compliance to established environmental standards. Please read the following instructions carefully before operating your machine, and refer to them as needed to ensure the continued safe operation of your machine.

Follow all warnings and instructions marked on or supplied with the product.

Symbology:  = High Voltage  = Warning

 = Heated Surface (Fuser, Scanner motor, Scanner motor bracket, Scanner motor cover)



WARNING: Use of the controls, adjustments or performance of procedures other than those specified herein may result in a hazardous radiation exposure.

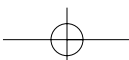



1

Installation

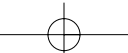

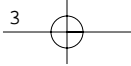



Unpacking

Once you have unpacked your machine, check to make sure that you have all the parts shown here.

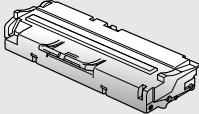
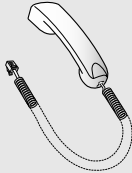
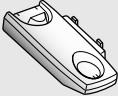
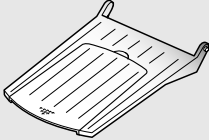
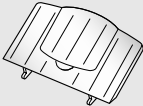
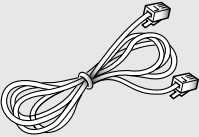
If any piece is missing or broken, call your dealer.

 <p>Machine</p>	 <p>Toner cartridge</p>	 <p>Handset</p>
 <p>Handset cradle</p>	 <p>Document exit tray</p>	 <p>Document tray</p>
 <p>Power cord *</p>	 <p>Telephone/modem line cord *</p>	 <p>Laser facsimile user's guide</p>
 <p>One-touch label</p>	<p><i>* These parts may look different. The appearance varies according to country.</i></p>	

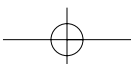



Control locations and functions

Take a moment to familiarize yourself with the main components and to understand their functions.

Front view

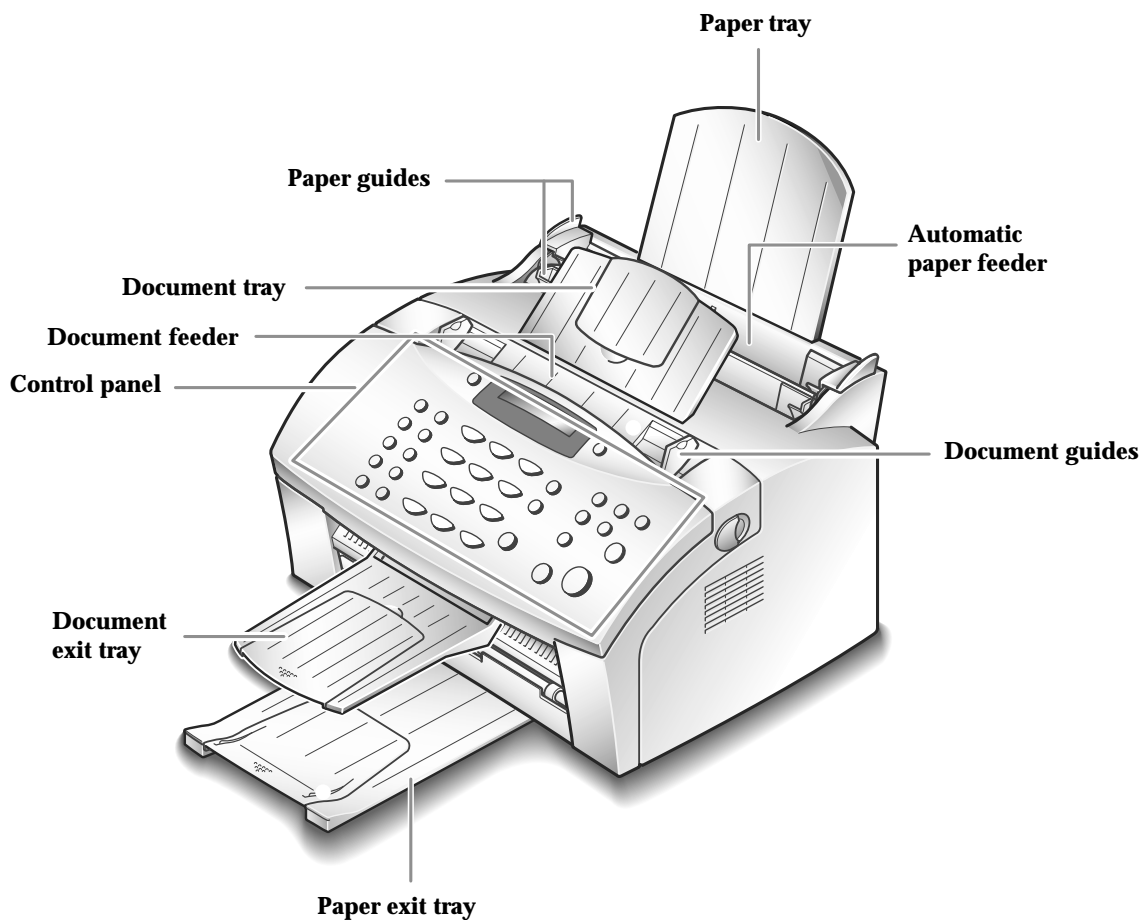

Note: Your machine may look slightly different than the illustration.

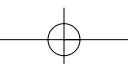



Rear view

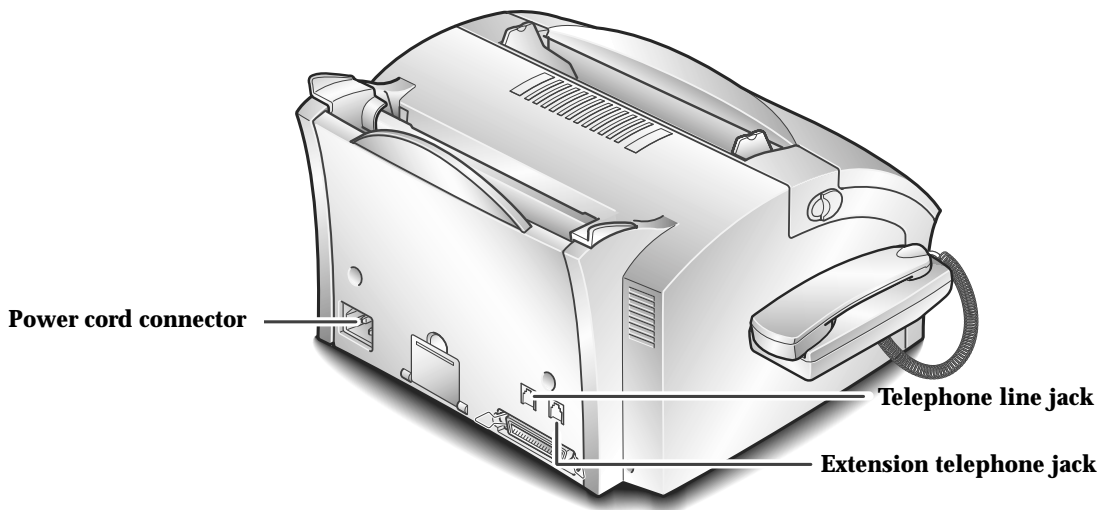

Inside

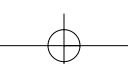
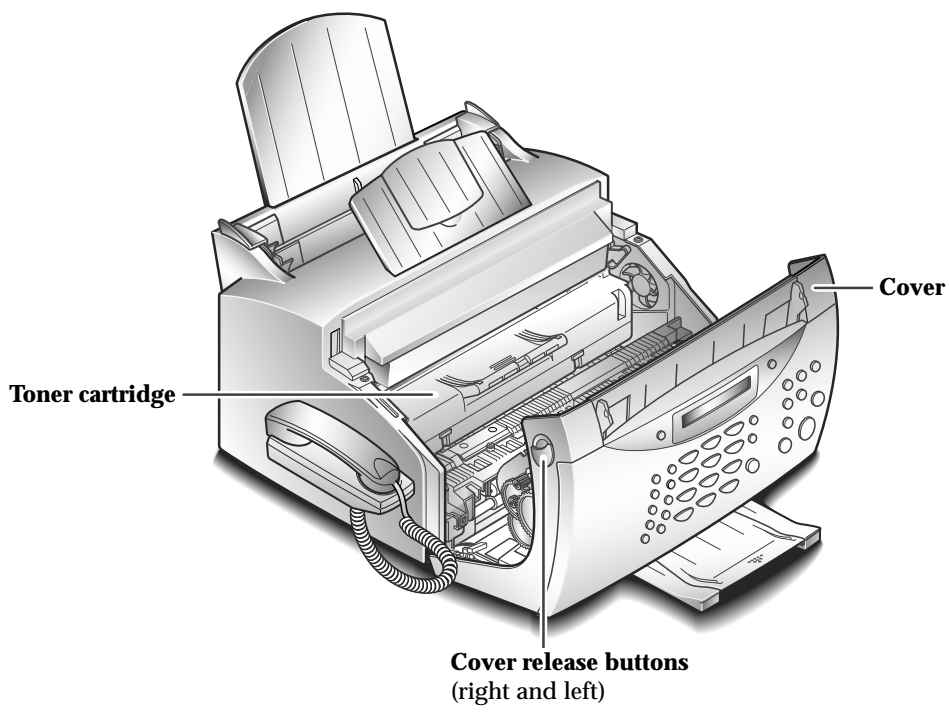

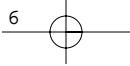

Choosing a location

To help guarantee the trouble-free operation of your machine, place it on a flat, stable surface near your workstation. Leave enough space to allow for easy paper loading and paper exiting, as well as opening the front cover.

Do not place your machine:

- In direct sunlight.
- Near heat sources or air conditioners.
- In dusty or dirty environments.

Setting up your machine

Document tray

Insert two tabs on the tray into the slots as shown. Fold out the extender on the tray, if necessary.

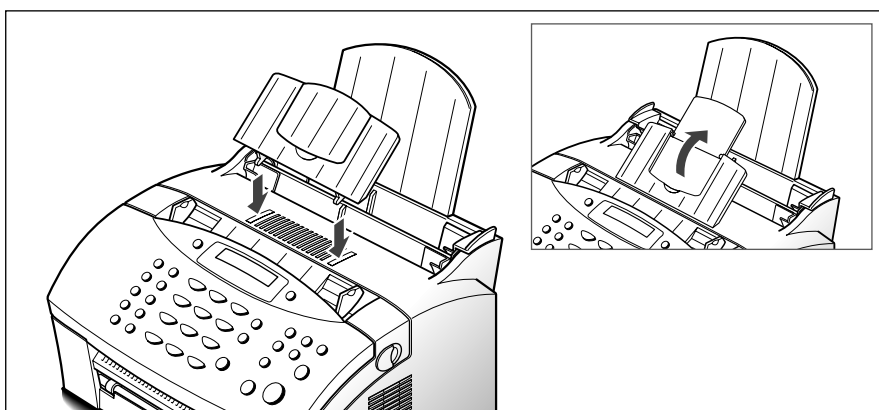

Paper exit tray

Pull out the paper exit tray on the front of your machine. Fold out the extender on the tray, if necessary.

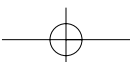
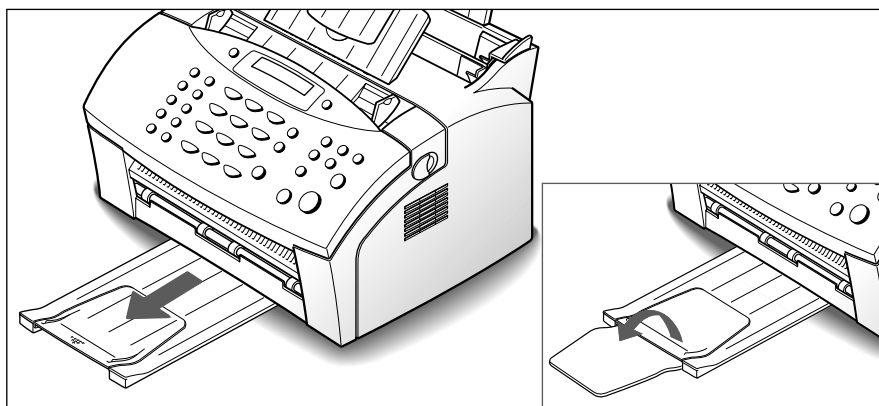



Document exit tray

Insert the two tabs on the document exit tray into the slots on the front of your machine. Fold out the extender, if necessary.

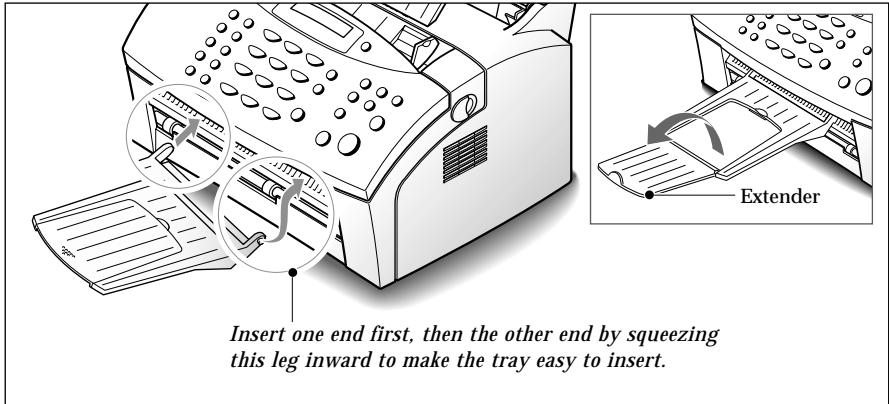

Handset and handset cradle

1. Plug the end of the coiled cord of the handset into the jack on the left side of your machine.

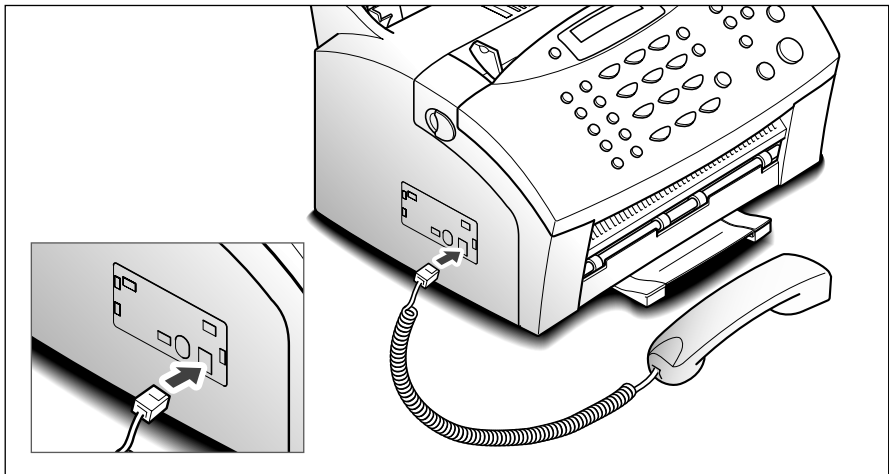

2. Hold the cradle using your hand as shown.

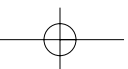
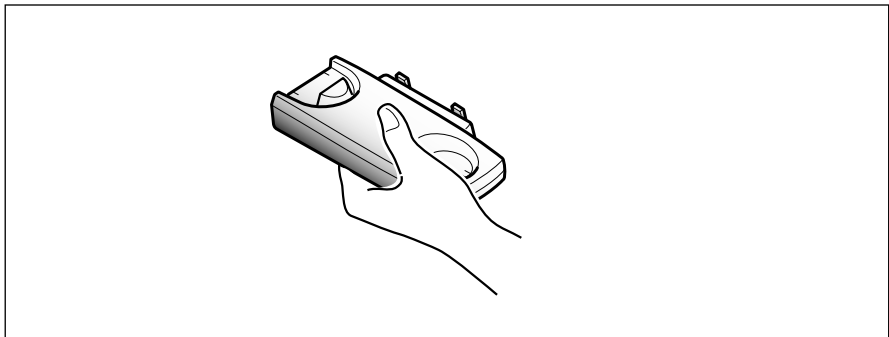

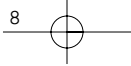

3. Attach the handset cradle to the main body.

Insert the two tabs of the cradle into the slots on the left side of the machine as shown, and while pressing part (A) on the bottom of the cradle, push the cradle toward the machine until it clicks into place.

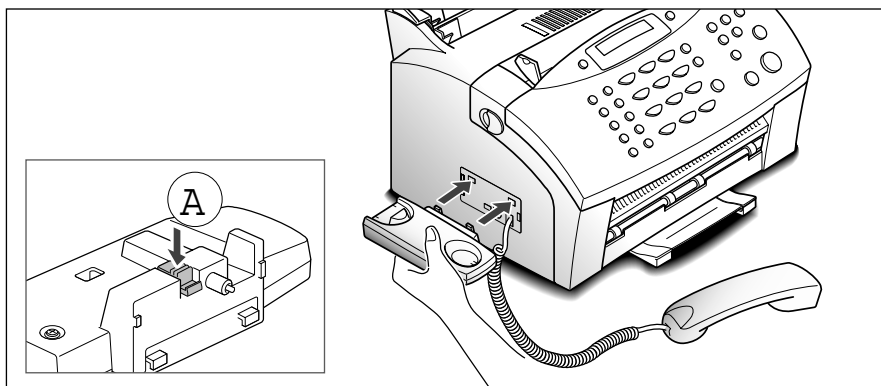

Note:

- *There is a one-touch plate built under the handset cradle. You can use this plate with the supplied one-touch label sheet. Write information on the label to remind you which number is stored in each position and attach the label on the plate.*

To find the desired number, rotate the plate facing you and slide it under the cradle when you are using the plate.

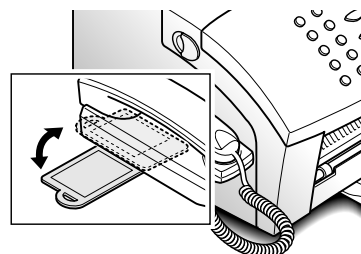

- *If you want to remove the cradle, while pushing up the part (A), on the bottom of the cradle, slide the cradle down, then take it out.*

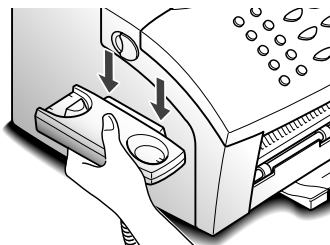

- *If your hearing is bad and you want a louder speaker, set the lever on the handset to the right position. You can hear louder sound from the handset.*

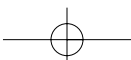
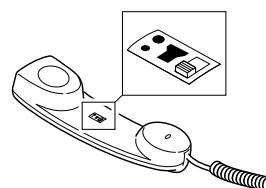

Telephone line

Plug one end of the telephone line cord into the LINE jack on the back of the machine and the other end into a standard phone wall jack.

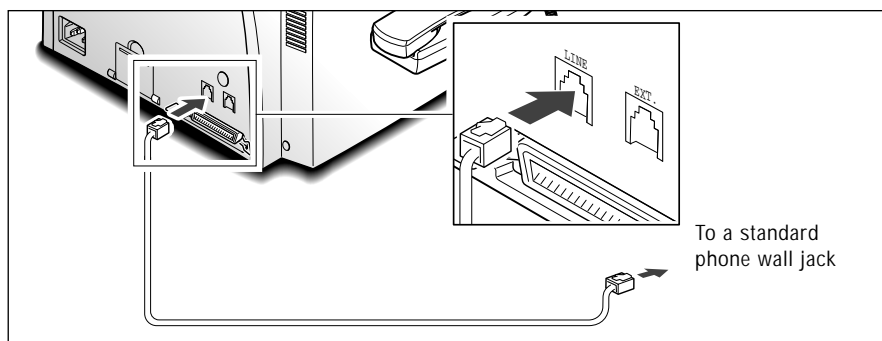

Note: You must use the telephone line cord which is supplied with your machine.

Extension phone (optional)

If you want to use a regular phone or answering machine with your machine, connect the phone into the EXT. jack.

Plug the cord of your regular phone or answering machine into the TAM (telephone answering machine) lead and plug the TAD (telephone answering device) lead into the EXT. jack at the back of the machine.

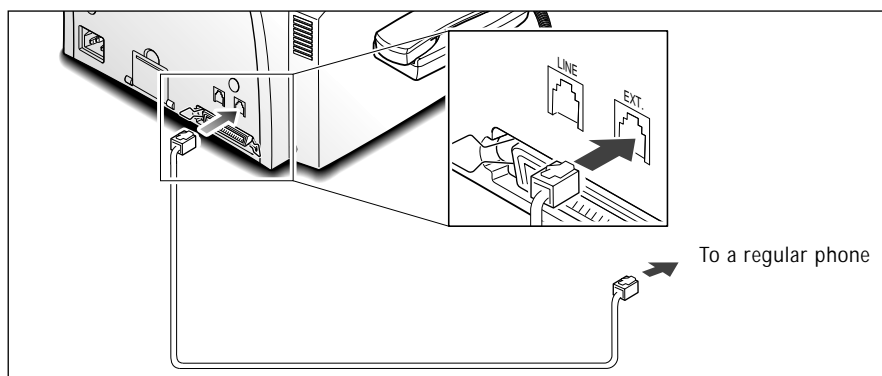

AC power cord

Plug one end of the cord into the back of the machine and the other end into a standard AC power outlet.

The machine will turn on and the display will show 'SYSTEM INITIAL'. If there is no cartridge installed or no paper, the display will show 'JAM/NO CARTRIDGE' or 'NO PAPER'.

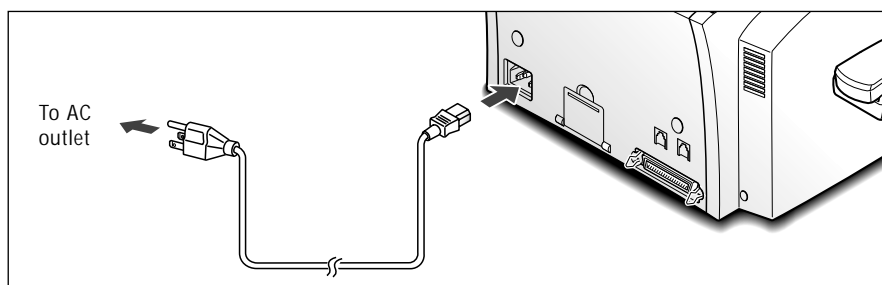

If you want to turn it off, unplug the power cord.



Installing the toner cartridge

- 1. Pulling the cover release buttons found on both sides of the machine toward you, open the cover.**



- 2. Unpack the cartridge from its plastic bag, and then remove the paper rolled the cartridge. Holding on each end of the paper, pull it straight out, and then carefully remove it.**

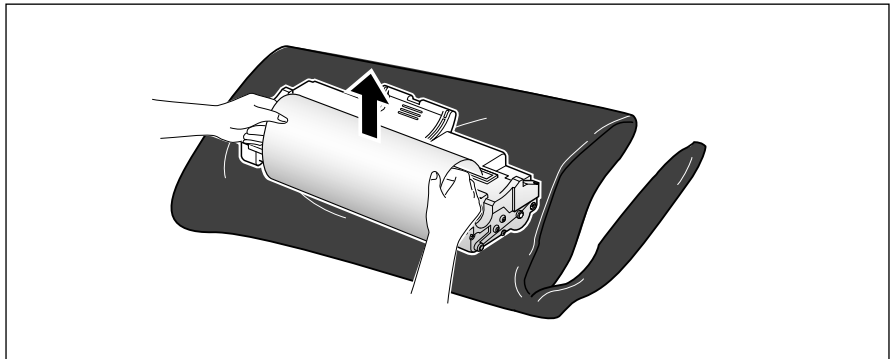

- 3. Shake the cartridge from side to side 5 or 6 times to redistribute the toner evenly inside the cartridge.**

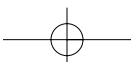
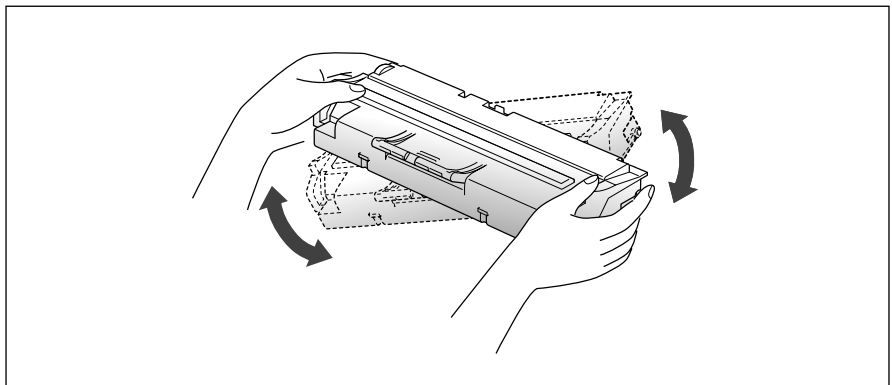



4. Find the cartridge slots inside the machine, one on each side.

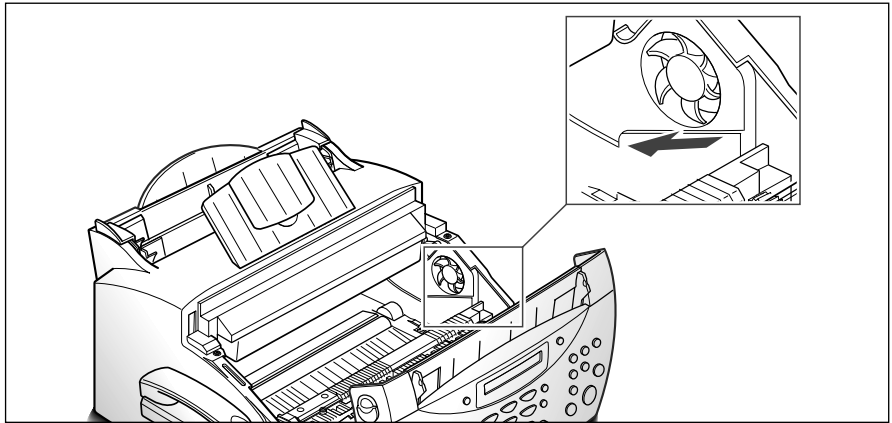

5. Grasp the handle at the front of the cartridge and slide it down between the cartridge slots, and push it firmly.

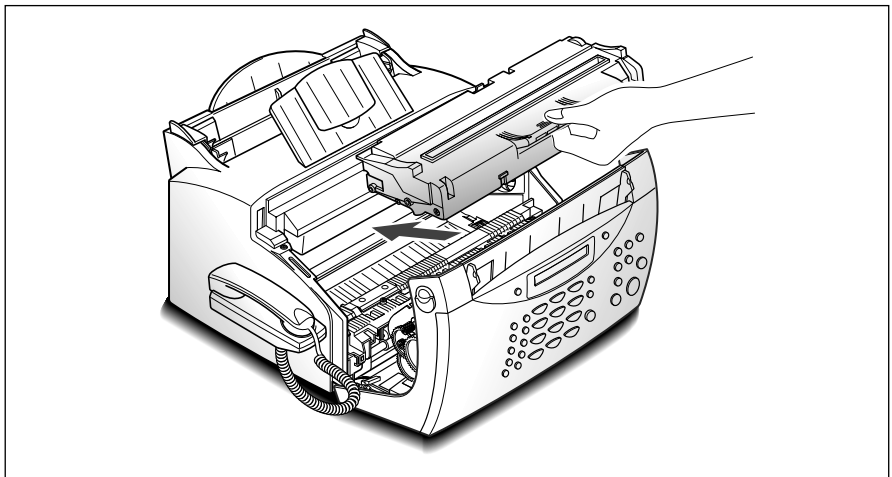

6. Close the cover. Make sure that the cover is securely closed.

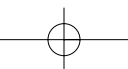
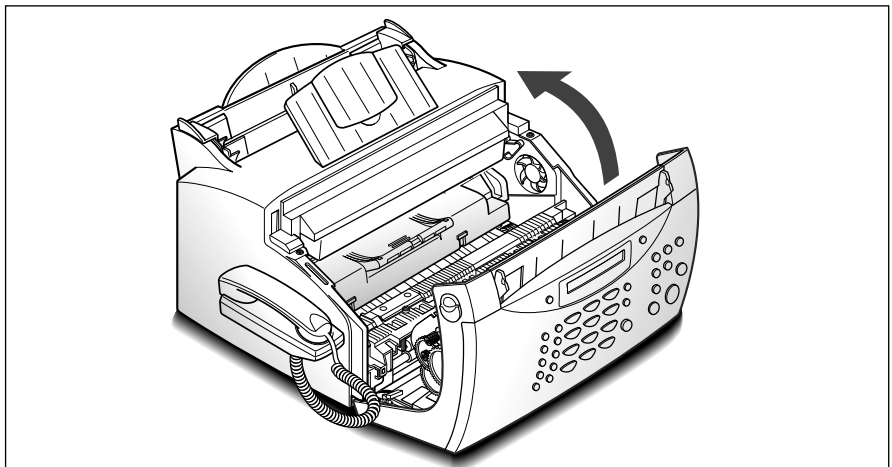



Loading paper

For best results, use high quality xerographic paper. The automatic paper feeder can hold a maximum of 150 sheets of plain paper. The maximum capacity may be less, depending on the paper thickness.

- 1. Pull the paper tray on the automatic paper feeder all the way up.**

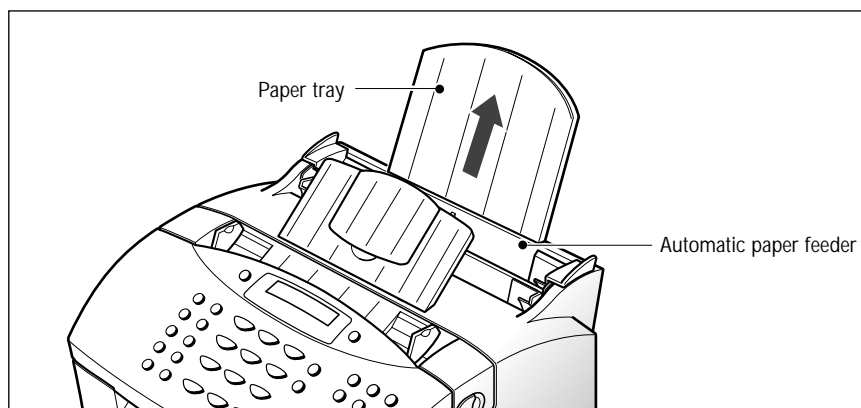

- 2. Flex or fan the paper back and forth. Do not fold or crease the paper. Straighten the edges on a level surface.**

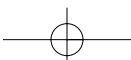
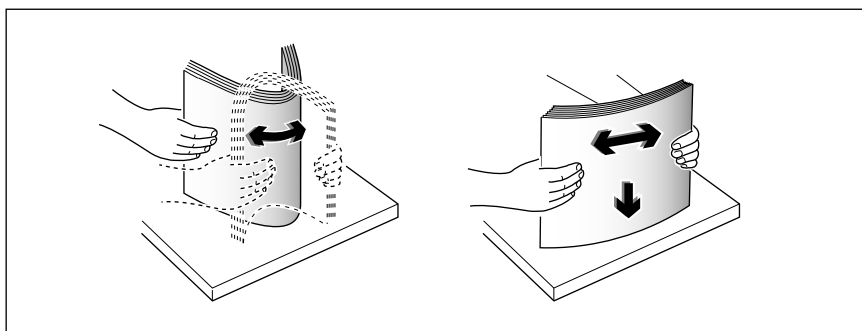



3. Insert the paper with the print side facing you.

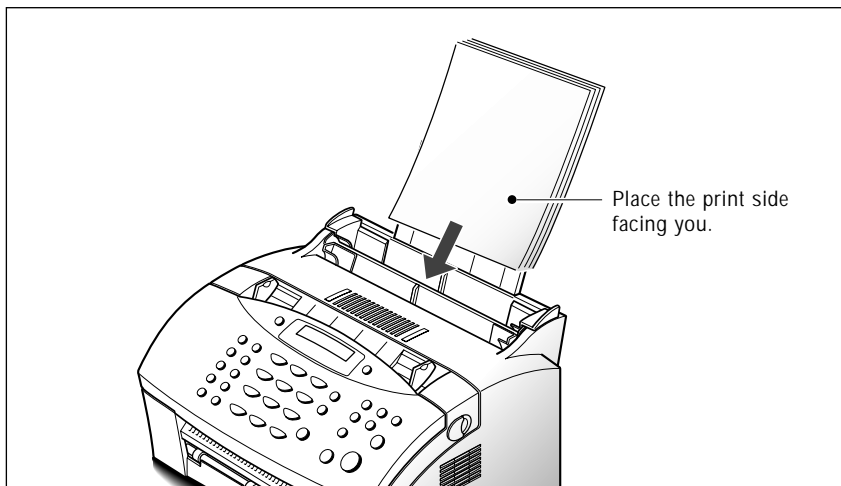

4. Adjust the paper guides to the width of the print material. Slide the guides until they lightly touch the stack of print material. Do not bend the print material.

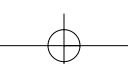
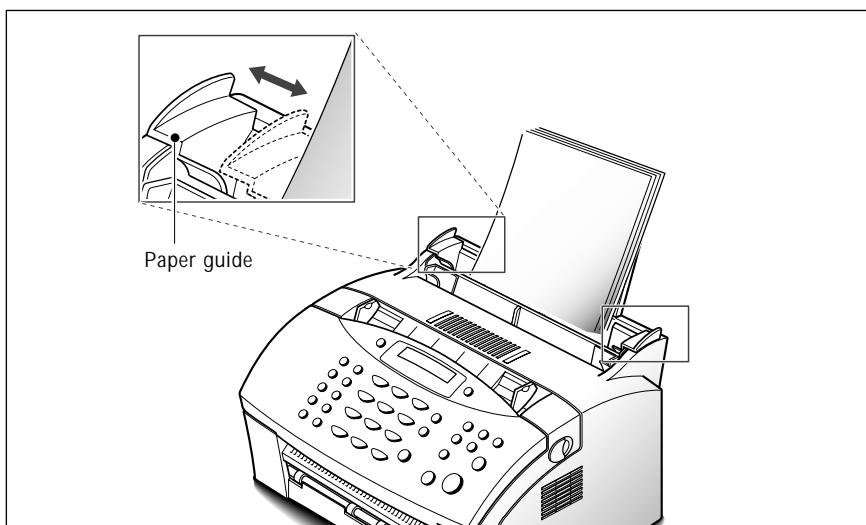



Paper type and size

Satisfactory print and receive quality can be obtained with many types of plain paper. Since the quality of plain paper varies widely, test the print quality before buying large quantities of paper. Your machine uses a variety of papers including:

- Xerographic paper
- Bond paper
- Dual-purpose paper

Because all papers vary in physical characteristics, you can receive mixed results from different packages of paper even through the packages contain the same paper. If you encounter undesirable results, try the other side of the paper, a different type, or another package of the same kind of paper.

DO NOT use the following types of paper with your machine:

- Continuous form feed paper
- Synthetic paper
- Thermal paper
- Multi-sheet forms and documents
- Chemically treated paper
- Papers with raised, embossed lettering

To load paper with a preferred print side:

- If you are using xerographic paper, load the paper with the preferred print side facing down.
- If you are using letterhead or bond paper, load the paper with the preferred side facing up.

The following papers can be used in your machine for fax:

- Letter : 216 x 279 mm (8.5 x 11.0 in.) - 60 g/m² ~ 90 g/m² (16 ~ 24 lb)
- A4 : 210 x 297 mm (8.3 x 11.7 in.) - 60 g/m² ~ 90 g/m² (16 ~ 24 lb)
- Legal : 216 x 356 mm (8.5 x 14.0 in.) - 60 g/m² ~ 90 g/m² (16 ~ 24 lb)

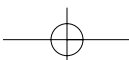



Printing a demo page

After installation, you may want to run a simple test on your machine by printing out a demo page.

Press and hold down Demo (* button) on the control panel until the machine to print a demo page.

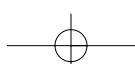

2

Getting started



Using the control panel

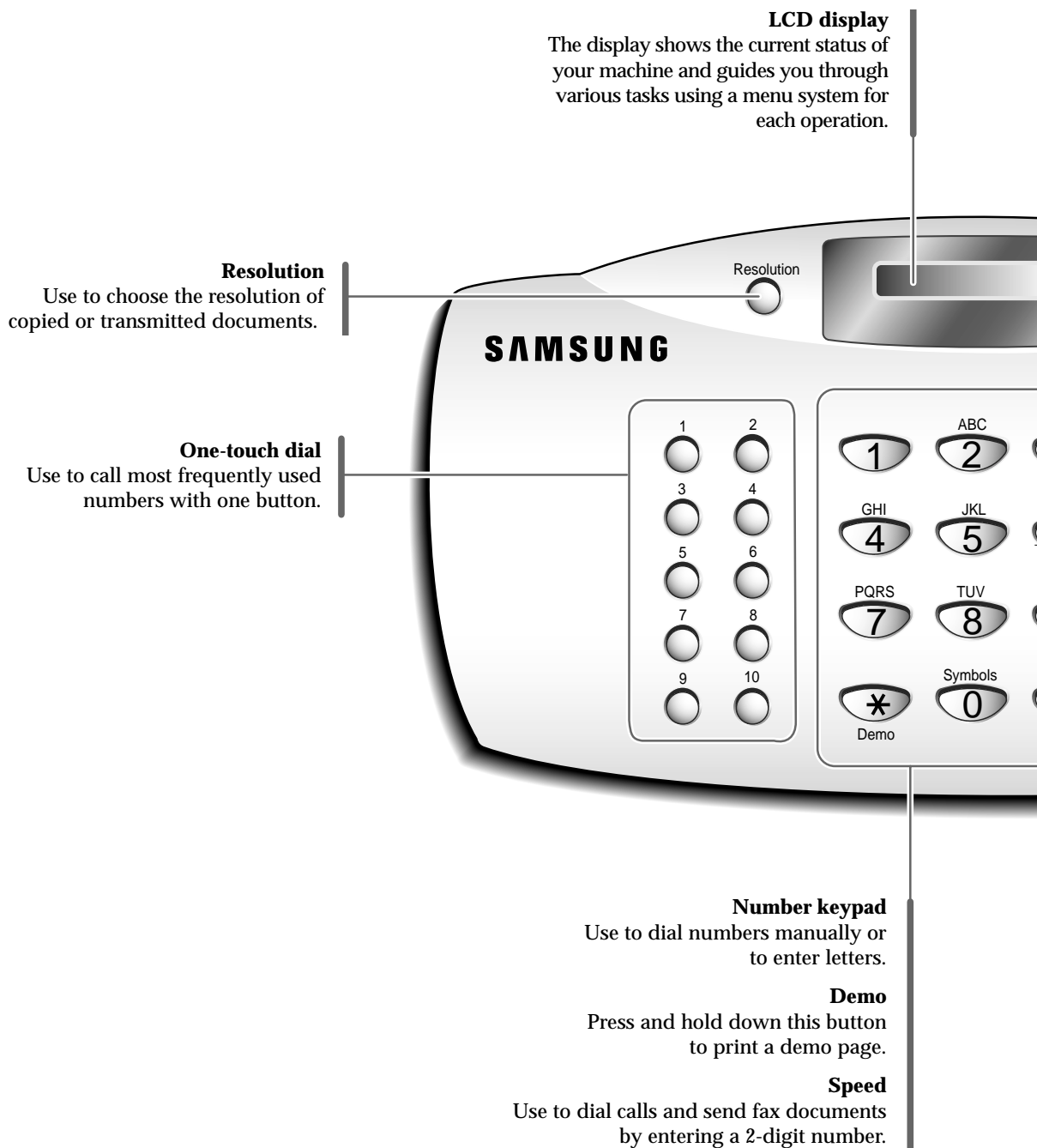

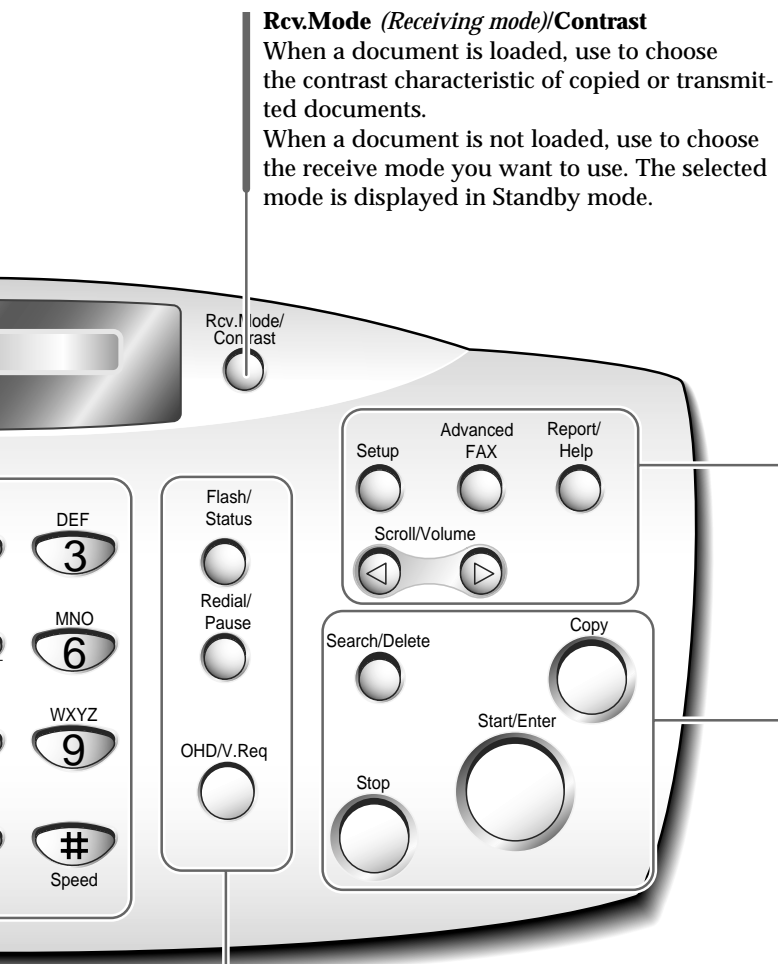
**Rcv.Mode (Receiving mode)/Contrast**

When a document is loaded, use to choose the contrast characteristic of copied or transmitted documents.

When a document is not loaded, use to choose the receive mode you want to use. The selected mode is displayed in Standby mode.

Setup

Use to setup various system options.

Advanced Fax

Use to access various fax functions.

Report/Help

Use to print various reports and the help list.

◀ Scroll/Volume ▶

Use to scroll menu items or use to move cursor left or right through the display. Also use to adjust the ringer volume.

Search/Delete

Use to search for numbers in the memory. Also use to delete digits in the edit mode.

Copy

Use to copy a document.

Start/Enter

Use to start a job. Also use to activate the selection shown on the display.

Stop

Use to stop an operation at any time.

Flash/Status

Use to perform a switch-hook operation such as call waiting. Also use to switch the LCD while performing dual jobs.

Redial/Pause

Use to redial the last phone number called. You can also use it to add a pause when storing a number in the memory.

OHD (On-hook dial) / V.Req (Voice request)

Use to dial numbers without picking up the handset. Also use it to make a voice call after sending or receiving a fax.

Using the number keypad

As you perform various tasks, you will need to enter names and numbers. For example, when you set up your machine you enter your name (or your company's name) and telephone number. When you store a one-touch dial or speed dial, you also enter the telephone numbers and names.

When the display asks you to enter a name, the LCD display reads:

NAME: _

You can use the procedures described below to enter alphanumeric characters, special symbols or spaces.

Entering alphanumeric characters

You can also include special symbols (space, plus sign, etc.) in the name by using the **0** key. See 'KEYPAD CHARACTER ASSIGNMENTS' on page 2.4.

1. **Locate the button labeled with the letter you want – then press the button repeatedly until the correct letter appears on the display.**

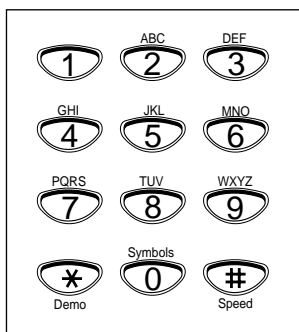

For example, to enter an O, press **6** (labeled MNO). Each time you press **6**, the display shows a different letter—first M, then N, and O, and finally 6.

The letter appears on the display as shown below.

NAME: O

2. When the letter you want appears on the display, press another number key labeled with the next letter you want.

If the next letter is printed on the same number button, move the cursor by pressing **▶**, then press the button.

The blinking cursor moves right and the next letter appears on the display.



3. Select additional letters in the same way. When you have finished entering the letters, press Start/Enter.

KEYPAD CHARACTER ASSIGNMENTS

Key	Assigned numbers, letters, or characters
1	Space → 1
2	A → B → C → 2
3	D → E → F → 3
4	G → H → I → 4
5	J → K → L → 5
6	M → N → O → 6
7	P → Q → R → S → 7
8	T → U → V → 8
9	W → X → Y → Z → 9
0	+ → - → , → . → ' → / → * → # → & → 0



Entering numbers

You can enter the number of the remote fax machine manually by using the number keypad. The number you pressed appears on the display.



When the display asks you to enter a number, you can also use a one-touch dial button (including group dial) or a 2-digit speed dial number.

Editing numbers or name

If you make a mistake while entering a number or name, move the cursor under the wrong digit by using ◀ or ▶. Then press the correct number to change, or press **Search/Delete** to delete the number.

Inserting pause

With some private telephone systems, you must dial an access code (9, for example) and listen for a second dial tone before dialing an outside number. In such cases, you must insert a pause in the number. Insert a pause in a number when you are setting up a one-touch or a speed dial number, or when you dial a number without lifting the handset.

To insert a pause, press Redial/Pause while entering the number.

When you dial a number, the dialing process pauses for a specified time at the point where you pressed **Redial/Pause**.

If you require a longer pause time, press **Redial/Pause** twice.

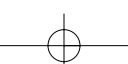

Setting up your fax number and name

Your fax number and name will be printed at the top of each page sent from your machine.

- 1. Press Setup on the control panel.** The display shows the first setup menu; FAX NUMBER/NAME.
- 2. Press Start/Enter to access the Fax Number/Name menu.** The display shows 'FAX NUMBER'.
- 3. Press Start/Enter.** The display asks you to enter the telephone number.

If there is a number or name already set, the number or name appears.

- 4. Enter the telephone number which your machine is connected to.** You can include + and - symbol in the phone number by pressing * and # button respectively.

If you make a mistake, press ◀ or ▶ to move the cursor under the wrong digit, then enter the correct number to change or press **Search/Delete** to delete the number.

- 5. Press Start/Enter when the number on the display is correct.** The display asks you to enter your name.

- 6. Enter your name using number keypad.**

You can enter alphanumeric characters using the number keypad, and include special symbols by pressing 0 repeatedly.

For details on how to use the number keypad to enter alphanumeric characters, see page 2.3.

If you want to enter the same letter or number in succession (e.g. SS, AA, 777), enter one digit, then move the cursor by pressing the ▶ button, and enter the next digit.

If you want to insert a space in the name, you can also use the ▶ button to move the cursor to skip the position.

- 7. Press Start/Enter when the name on the display is correct.**

Setting the time and date

The current time and date are shown on the display when the machine is on and ready for use (standby mode). The time and date are printed on all faxes you send.

Note: If power to the machine is cut off for over 30 minutes, when power is restored, the machine prompts you to reset the time and date.

- 1. Press Setup.** The display shows the first setup menu; FAX NUMBER/NAME.
- 2. Press ◀ or ▶ until 'TIME/DATE SETUP' appears, then press Start/Enter.** The display asks you to choose a date format.
- 3. Press Start/Enter.**
- 4. Press ◀ or ▶ until you find the desired date format, then press Start/Enter.**

If you select USA, the time and date appears in the order of month, day, then year. The EUROPE format will be displayed in the order of day, month, then year.

The display shows the currently set time and date using the selected date format.

06-25-1999 12:30 ('USA' type)

- 5. Enter the correct time and date using the number keypad.**

Day	= 01~31
Month	= 01~12
Year	= four digits
Hour	= 00~23
Minute	= 00~59

You can also use ◀ or ▶ to move the cursor under the digit you want to correct, then enter a new number.

- 6. Press Start/Enter when the time and date on the display is correct.**

If you enter an invalid number, the machine beeps and does not proceed to the next step. If this happens, just reenter the correct number.

The display shows the time and date you have set, then returns to standby mode.

JUN-25 12:30 FAX



Adjusting volume

Ringer volume

1. Press ◀ or ▶ in standby mode.

The display shows the current ringer volume setting.

2. Press ◀ or ▶ until you find the desired loudness. Four levels are available; 0~3.

You will hear the selected volume and the display will show the level. Setting '0' turns the ringer off. The machine will work normally even if the ringer is set to off.

3. The change stores into memory and the machine returns to standby mode.

Speaker volume

1. Press OHD/V.Reg to adjust the speaker volume. If you cannot hear dial tone, check the phone line connection.

2. Press ◀ or ▶ repeatedly until you find the desired loudness. The display shows the current volume level.

3. The change stores into memory and the machine returns to standby mode.

Alarm volume/Key volume

If you set the alarm volume menu ON, alarm tone sounds when an error occurs. If you set the key volume menu ON, key tone sounds each time any key is pressed.

1. Press Setup and ◀ or ▶ until 'VOLUME SETUP' appears, then press Start/Enter. The display shows 'ALARM VOLUME'.
2. Press Start/Enter to access the Alarm Volume menu. To access the Key Volume menu, press ◀ or ▶ until 'KEY VOLUME' appears, then press Start/Enter.
3. Press ◀ or ▶ to turn the sound ON or OFF, then press Start/Enter.
4. To return to standby mode, press Stop.

	KEY volume ON	KEY volume OFF
DIAL volume	ON	1)*Auto dial : OFF 2) Manual dial : ON
KEY volume	ON	OFF

*Auto dial : Broadcasting, Delay TX, Priority TX, Onetouch/Speed dial TX

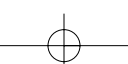

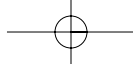

3

Basic operation

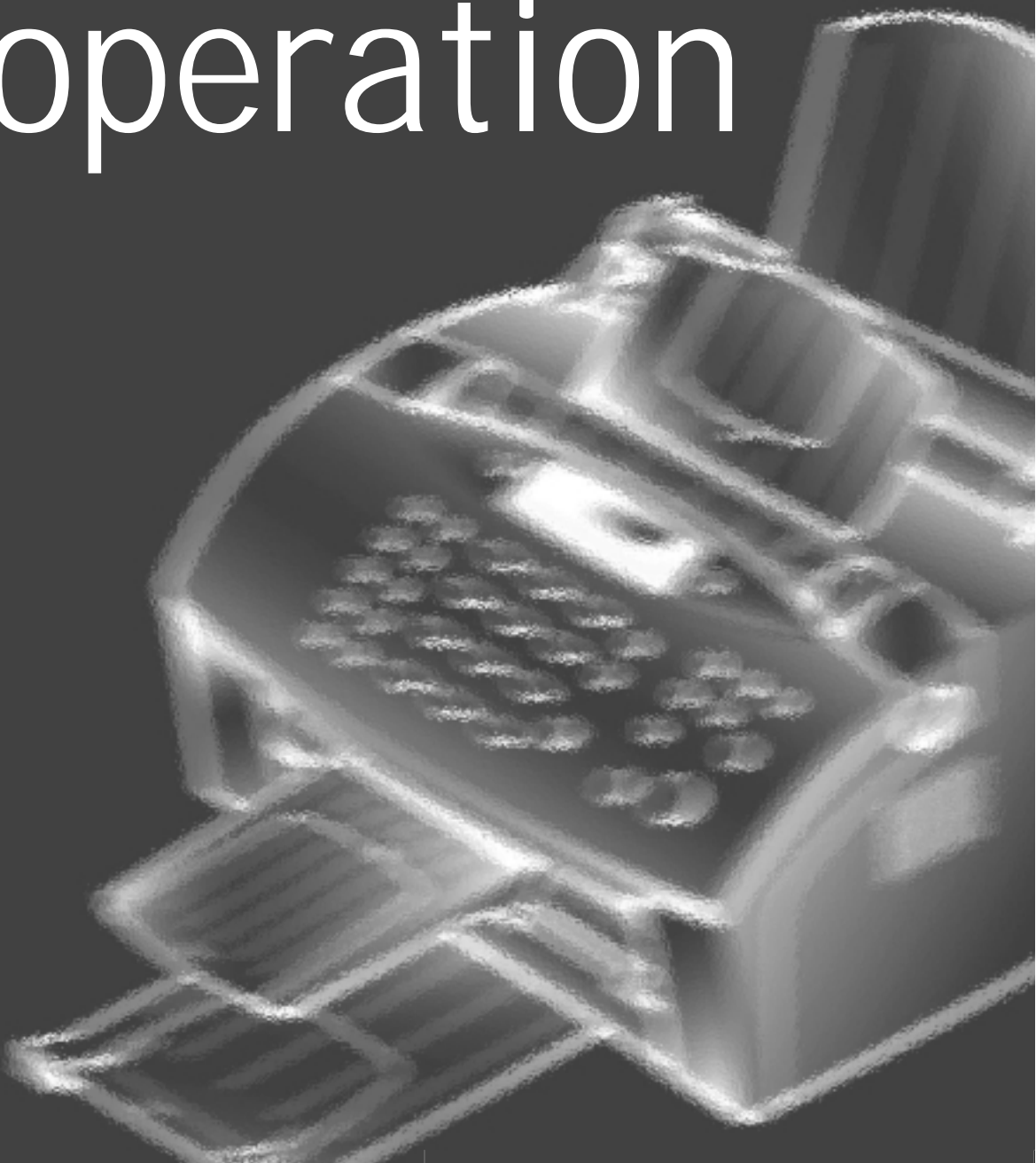

Sending a fax



Preparing documents for faxing or copying

You can use the machine to fax or copy documents that are printed on standard letter or A4 size paper. Follow these guidelines to prepare your documents.

- Do not attempt to feed the following types of documents into the machine:
 - wrinkled, curled, or folded paper
 - chemically processed paper (pressure-sensitive paper, carbon-coated paper, etc.)
 - coated paper (glossy, etc.)
 - too thin (onion skin, airmail paper, etc.)
 - too thick paper
 - too small or short paper (such as a label, voucher, etc.)
 - the paper which is made of cloth or metal

Instead, make copies using a standard copy machine and insert the copies into the document tray.

- Remove all staples, paper clips and the like before feeding the document.
- Make sure any glue, ink or correction fluid on the paper is completely dry before feeding the document.
- Do not feed documents with pages that are different sizes or of different thicknesses.

ACCEPTABLE DOCUMENTS (for ADF¹)

		Single sheet	2 or more sheets
Document size	Max	8.5 in. (W) x 14 in. (L) (216 mm x 356 mm)	8.5 in. (W) x 11.7 in. (L) (216 mm x 297 mm)
	Min	5.8 in. (W) x 5.0 in. (L) (148 mm x 128 mm)	
Effective scanning width		8.26 in. (210 mm)	
Number of sheets which can be loaded at a time			Up to 20
Thickness of document		0.07 mm ~ 0.15 mm	0.075 mm ~ 0.12 mm
Print quality		Uncoated on both sides	

¹ ADF stands for Automatic Document Feeder. It allows you to stack original documents, which will be faxed or copied one by one.

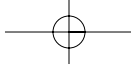

Setting document resolution and contrast

We recommend sending documents printed using a typewriter, felt tip pen, black ink or laserwriter. The paper should be white or very light, and of normal weight – not cardboard. Blue lines on a ruled pad do not fax well.

When you send normal documents, you need not adjust the resolution and the contrast.

If you send documents with unusual contrast characteristics, including photographs, you can adjust the resolution and contrast to send a high-quality transmission of the documents.

Resolution

Press the Resolution button to increase sharpness and clarity. By pressing the **Resolution** button repeatedly after loading a document, you can choose between **STANDARD**, **FINE** or **SUPER FINE** mode.

STANDARD works well for documents with normal sized characters.

FINE is good for documents containing small characters or thin lines, or print from a dot-matrix printer.

SUPER FINE works well for documents containing extremely fine details. **SUPER FINE** works only if the remote machine also has the **SUPER FINE** features.

Contrast

Press the Rcv.Mode/Contrast button to compensate for the brightness or darkness of your outgoing document. By pressing the **Rcv.Mode/Contrast** button repeatedly after loading a document, you can choose between **NORMAL**, **DARKEN**, **LIGHTEN** or **PHOTO**.

NORMAL works well for normal documents.

DARKEN works well for light print or faint pencil markings. The light image and text on the document will be darker on the printed page.

LIGHTEN works well for dark print. The dark image and text on the document will be lighter on the printed page.

PHOTO is used when faxing photographs or other documents containing color or shades of gray. Although your machine will not transmit color, it will print and send up to 64 shades of gray. When you choose this mode, you should set the resolution to **FINE**.

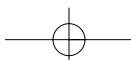

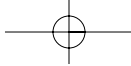

Loading document

1. Turn the page face down.
2. Adjust the document guides to match the width of the document.
3. Slide the sheet down into the document feeder until it is gripped by the machine.

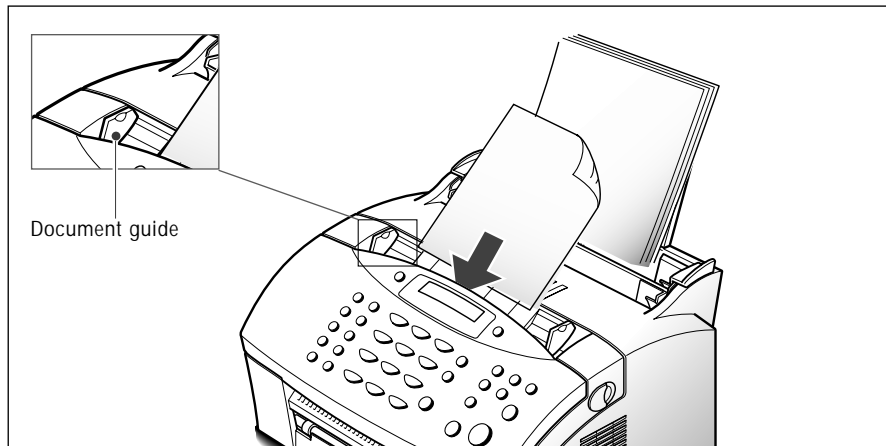

The automatic document feeder seizes and pulls in the page.

You can insert up to 20 sheets at a time. If you insert more than one sheet, make sure the bottom sheet enters first. Stagger the leading edge of the sheets slightly, and insert the sheets with a slight push to ensure they feed smoothly.

To add pages while the fax is being sent, insert them into the loading slot on top of the already loaded sheets.

4. If necessary, use the **Resolution** and **Rcv.Mode/Contrast** button to change the resolution and the contrast (see page 3.2).

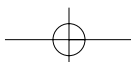

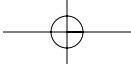

Sending a fax automatically

1. **After loading a document, enter the number of the remote fax machine using the number keypad.**

One-touch or speed dialing is also available if you have already stored the number into a one-touch or speed dial number. For information on storing and using numbers in the memory, see page 3.14.

If you make a mistake while entering a number, move the cursor under the wrong digit by using ◀ or ▶, and correct the number or press **Search/Delete** to delete the number.

2. **Press Start/Enter when the number appears correctly on the display.** The machine dials the number, then begins to transmit.

Sending a fax after talking

1. **After loading a document, pick up the handset and call the remote machine.**
2. **Press Start/Enter after you finish talking.** The machine begins to transmit.
3. **Replace the handset.**

Canceling transmission

Press **Stop** any time during transmission. The machine continues to send the fax and the display shows a message warning you that the machine is in use. Press **Stop** again.

Confirming transmission

When the last page of your document has been sent successfully, the machine beeps and returns to standby mode.

If something went wrong during your fax transmission, an error message appears on the display. For a listing of error messages and their meanings, see page 6.5.

If you receive an error message, press **Stop** to clear the message and try to send the document again.

You can set your machine to print out a confirmation report automatically each time sending is completed. For more information, see 'SENDING CONFIRM' on page 5.3.

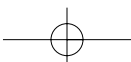

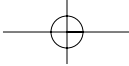

Automatic redial

When you send a fax, if the number you have dialled is busy or there is no answer, the machine will automatically redial the number every three minutes up to a maximum of two times.

The display shows 'RETRY REDIAL?'. To redial the number without waiting, press **Start/Enter**. To cancel the automatic redial, press **Stop**.

Voice request

If you are sending or receiving a document and need to speak to the other person during the same phone call, use voice request to alert the person at the remote site. You can also respond to a voice request made by the person at the remote end.

Sending a voice request

- 1. Press OHD/V.Req while a document is being sent or received.** Voice request signal is stored and then sent to the remote fax machine after the document has been sent or received.
- 2. When the phone rings, pick up the handset and answer it.**

You can cancel a voice request by pressing **OHD/V.Req** again while you are sending or receiving a document.

Answering a voice request

When the phone rings after sending or receiving a fax, pick up the handset and answer it.

If you do not answer the voice request, the machine prints out the number that made the voice request, as well as the time and date that the request was made.

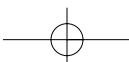

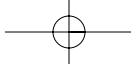

Receiving a fax



Receiving a fax

Receiving modes

Your machine has four receiving modes:

- In **FAX** mode, the machine answers an incoming call and immediately goes into receive mode, waiting for a fax to be sent.
- In **AUTO** mode, the machine answers an incoming call expecting to receive a fax. If the machine does not sense a fax signal, it will continue to sound the ringing tone to tell you it is a phone call. If you do not lift the handset during the ringing, the machine will switch to automatic fax receiving mode.
- In **ANS/FAX** mode, the answering machine answers an incoming call, and the caller can leave a message on the answering machine. If the fax machine senses a fax tone on the line, the call automatically switches over to the fax machine. To use the ANS/FAX mode, you have to attach an answering machine to the extension telephone jack on your fax machine (see page 1.7).
- In **TEL** mode, the automatic fax reception is turned off. You can receive a fax only by picking up the handset and pressing **Start/Enter**.

The current receiving mode is displayed when the machine is in standby mode.

JUN-25 15:30 **FAX** — Receiving mode

If you seldom use the fax line for voice conversations, set the fax machine to receive a fax automatically by selecting FAX mode.

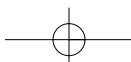

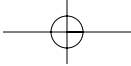

Distinctive ring pattern detection (DRPD)

You can receive a call using distinctive ring pattern detection (DRPD) feature. "Distinctive ring" is a telephone company service which enables a user to use a single telephone line to answer several different telephone numbers. For details on this feature, see page 5.6.

Receiving automatically in FAX mode

1. Press **Rcv.Mode/Contrast** until the display shows **'FAX MODE'**.
2. When you get a call, the machine answers the call on a specified number of rings and receives a fax automatically. You can change the number of rings. See **'RINGS TO ANSWER'** on page 5.4.

To adjust the ringer volume, see **'Adjusting volume'** on page 2.8.

Receiving manually in TEL mode

You can answer calls using the handset, and start the machine to receive a fax.

1. Press **Rcv.Mode/Contrast** until the display shows **'TEL MODE'**.
2. When the telephone rings, pick up the handset and answer it.
3. If you hear a fax tone, or if the person on the other end asks you to receive a document, press **Start/Enter**.
4. **Replace the handset.** The machine begins receiving and returns to standby mode when the reception is complete.

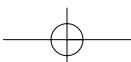

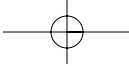

Receiving in AUTO mode

1. Press Rcv.Mode/Contrast until the display shows 'AUTO MODE'.

2. When you get a call, the machine answers it.

If a fax is being sent, the machine goes into receiving mode.

If the machine does not detect a fax signal, it will continue ringing to tell you it is a phone call. You should pick up the handset to answer the call, or it will switch to automatic receiving mode.

Receiving automatically in ANS/FAX mode

To use this mode, you must attach an answering machine to the extension telephone jack on the back of your machine (see page 1.7).

1. Press Rcv.Mode/Contrast until the display shows 'ANS/FAX MODE'.

2. When you get a call, the answering machine answers it. If the caller leaves a message, the answering machine stores the message normally.

If your machine hears a fax tone on the line, the fax receive mode is activated.

Notes:

- *If you have set your machine to ANS/FAX mode and your answering machine is switched off, or no answering machine is connected to your machine, the fax machine will automatically go into FAX mode after several rings.*
- *If your answering machine has a 'user-selectable ring counter', set the machine to answer incoming calls within 1 ring.*
- *If you are in TEL mode (manual reception) when the answering machine is connected to your machine, you must switch off the answering machine, or the outgoing message from the answering machine will interrupt your phone conversation.*

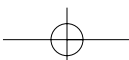

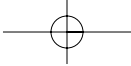

Receiving manually using an extension telephone

This feature works best when you are using an extension telephone connected to the extension telephone line jack on the machine. You can receive a fax from someone you are talking to on the extension telephone without having to go to the fax machine.

- 1. When you receive a call on the extension phone and hear fax tones, press the keys “ * 9 * ” (star nine star) on the extension telephone.**

The machine receives the document.

Press the buttons slowly in sequence. If you still hear the fax tone from the remote machine, try pressing “ * 9 * ” once again.

“ * 9 * ” is the remote receive start code preset at the factory. The first and the last asterisks are fixed, but you can change the middle number to whatever you choose.

For more information, see ‘RCV. START CODE’ on page 5.5.

- 2. When you have finished speaking and receiving documents, replace the handset of the extension telephone.**

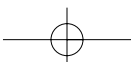

Making a copy

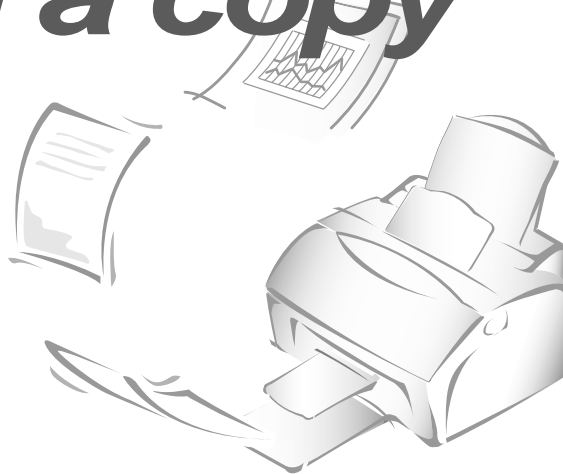

Copying overview

The resolution is automatically set to SUPER FINE while the copy feature is in use. However, the contrast can be changed to produce optimal copy quality for a particular document containing faint markings, dark image, photographs or other halftone images.

When you make a copy, your machine provides several option features you can choose as follows:

- Multiple copies** : 1 to 99 copies of the document can be made.
- Zoom rate** : You can reduce or expand the image size by 1% increments from 50% to 130%.
- Collation** : When this menu is set to ON, the machine sorts the print jobs. All pages of the document are printed in reverse order before the next copy is printed. For example, if you copy a three-page job to print 2 copies, the machine prints page 3, page 2, page 1, page 3, page 2, page 1.

Making a simple copy

To make a direct single copy without setting any options, take the following steps:

- 1. Load a document with the print side facing down.** If necessary, press **Rcv.Mode/Contrast** button to adjust the contrast. For details on the contrast, see page 3.2.
- 2. Press Copy twice.** The machine starts copying.

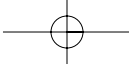

Advanced copy features

You can adjust the copy quantity, size and collation. Take the following steps:

1. **Load a document with the print side facing down.** If necessary, adjust **Rcv.Mode/Contrast** button to change the contrast. For details on the contrast, see page 3.2.
2. **Press Copy.** The display asks you to enter the number of copies (1 to 99).
3. **If you need two or more copies, enter the desired number using the number keypad, then press Start/Enter.** You can also press **Start/Enter** without setting the number of copies. The display shows the next option; zoom rate.
4. **If you want to reduce or expand the image size, enter the number of the desired zoom rate, then press Start/Enter.**

The display asks you to turn the copy collation on or off. Setting 'ON' will sort the print job.

5. **Press ◀ or ▶ to choose ON or OFF.**

OFF (Group)

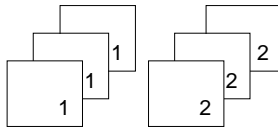

ON (Sort)

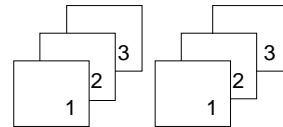

6. **Press Copy or Start/Enter to begin the copy operation.**

Note: When you set the copy options, pressing **Copy** anytime begins the copy operation immediately without displaying the remaining options.

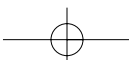

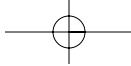

Other functions

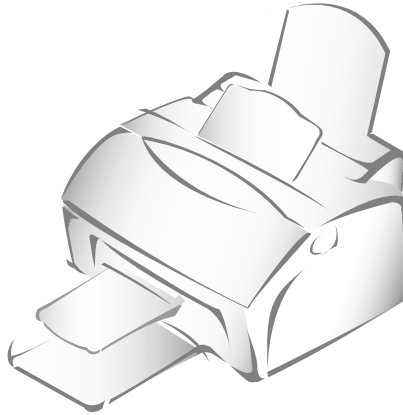

Redial

To redial the number last called

Press **Redial/Pause**. If a document is loaded in the document feeder, the machine automatically begins to send.

To search through redial memory

1. Press and hold Redial/Pause for 2 seconds.

The redial memory in your machine retains the last 2 numbers called. If you have dialled the same number multiple times, the machine does not count the duplicates.

2. Press ◀ or ▶ to search through the memory until you find the number you want.

3. When the number you want appears on the display, press Start/Enter to dial. If a document is loaded in the document feeder, the machine automatically begins to send.

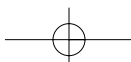

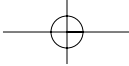

Sending a recall

Some special phone services require a switch-hook signal for proper operation. For example, if you have call-waiting, you can put a call on hold and take a second call on the same line by pressing the **Flash/Status** button.

- 1. When you are on the telephone and hear the call waiting signal, press Flash/Status once.** The first caller is on hold and you are speaking to the second caller.
- 2. Press Flash/Status again to talk to the first caller again.**

***Note:** If you do not have a special service that uses the switch-hook signal, do not press **Flash/Status** during a call. If you do, you could disconnect the line.*

Monitoring a dual job status

Your machine can perform more than one of many functions simultaneously. For example, you can :

- Receive a fax into the memory while making a copy.
- Store a fax document for later transmission while printing an incoming fax.

When the machine performs dual tasks, press Flash/Status to see the current status on the display of the other operation. Each time you press **Flash/Status**, the current status of the two operations displays alternatively.

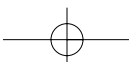

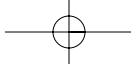

Automatic dialing

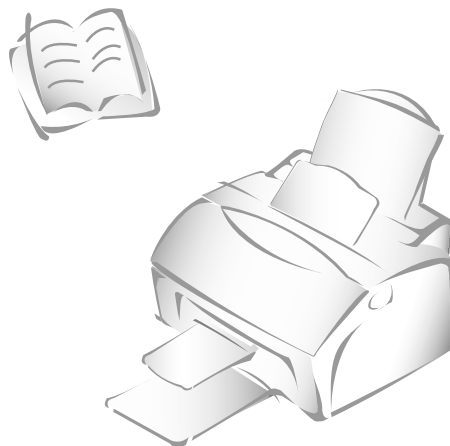

One-touch dialing

One-touch dialing lets you use any one of the 10 one-touch buttons to automatically dial a number.

Storing a number for one-touch dialing

1. **Press and hold one of ten one-touch buttons for 2 seconds that you want to assign.** The display shows 'Txx:', where 'xx' represents the selected one-touch button number.

Txx: _

2. **Enter the number you want to store by using the number keypad, then press Start/Enter.**

To insert a pause between numbers, press **Redial/Pause**; a 'P' appears on the display.

If you make a mistake while entering a number, use ◀ or ▶ to move the cursor under the wrong digit, then enter the correct digit, or press **Search/Delete**.

If the number is already assigned to another one-touch button, the display alerts you with the registered one-touch button, and asks you to continue storing another one-touch dial number.

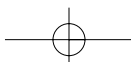

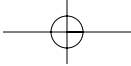

3. The display asks you to enter a name. **Enter the desired name.** For information on how to enter names, see page 2.3.

Or

If you do not want to assign a name, skip this step.

If you assign a name to the number, the name appears on the display when you press the one-touch button.

4. Press Start/Enter when the name appears correctly or without entering a name.

5. To set another one-touch number, press the desired one-touch button and repeat steps 2 through 4.

Or

To return to standby mode, press Stop.

Editing a number for one-touch dialing

If you press and hold the one-touch button where the phone number is already registered, the display shows the number.

TEL: 025413000

Press ◀ or ▶ to move the cursor to the desired number and edit the number. When you complete editing, press Start/Enter.

***Note:** When you press the one-touch button stored for group dial, the display briefly shows 'G-REGISTERED' to indicate that the button is used for group dial, then you can edit the number.*

Sending a fax using a one-touch number

1. Load a document you want to send by fax.

2. Press the one-touch button (1 through 10) where you stored a number. The number will be automatically dialled, then the document begins to transmit when the remote fax machine answers the phone.

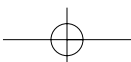

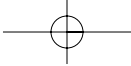

Speed dialing

You can store up to 80 numbers in 2-digit speed dial locations (01-80).

Storing a number for speed dialing

1. Press and hold **Speed** for 2 seconds.

LOC. [01 - 80] ► ##

2. Enter a 2-digit location number (01 through 80) where you want to store a number, then press **Start/Enter**.

If a number has already been stored in the location you chose, the display shows the number.

3. Enter the number you want to store, then press **Start/Enter**.

Sxx: 025413000

where xx represents the speed location you have selected at step 2.

If the number you entered has already been assigned to another speed location, the display alerts you with the registered speed location.

4. To assign a name to the number, enter the desired name. For information on how to enter names, see page 2.3.

Or

If you do not want to assign a name, skip this step.

5. Press **Start/Enter** when the name appears correctly or simply without entering a name.

6. To store more telephone numbers, repeat steps 2 through 5.

Or

To return to standby mode, press Stop.

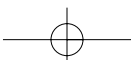

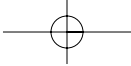

Editing a number for speed dialing

1. Press and hold **Speed** for 2 seconds.
2. Enter the 2-digit location number where the phone number you want to edit has been stored, then press **Start/Enter**. The display shows the number.

TEL: 025413000

3. Press ◀ or ▶ to move the cursor to the desired number and edit the number. When you complete editing, press **Start/Enter**.

Note: When you press the speed dial number stored for group dial, the display briefly shows 'G-REGISTERED' to indicate that the number is used for group dial, then you can edit the number.

Sending a fax using a speed number

1. Load a document that you want to send by fax.
2. Press **Speed**, then enter a 2-digit speed dial location number.
3. Press **Start/Enter** to dial the number. The number will be automatically dialed, then the document will begin to be transmitted when the remote fax machine answers the phone.

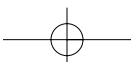

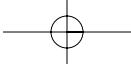

Searching for a number in the memory

There are two ways to search for a number in the memory. You can either scan from A to Z sequentially, or you can search using the first letter of the name associated with the number.

Searching sequentially through the memory

1. Press **Search/Delete**, then press **▶** to move downward through the memory until you find the number you want. To move upward, press **◀**.

Pressing **▶** allows you to search downward through the entire memory in alphabetical order (from A to Z), and **◀** allows you to search upward in reverse alphabetical order (from Z to A).

Each time you press **◀** or **▶**, the display shows the next number stored in the memory.

While searching through the machine's memory, you will see that each entry is preceded by one of three letters: 'T' for one-touch dial, 'S' for speed, or 'G' for group dial number. These letters tell you how the number is stored.

2. When the number you want appears on the display, press **Start/Enter to dial**.

If a document is loaded, the document begins to be transmitted when the remote fax machine answers the phone.

Searching with a particular first letter

1. Press **Search/Delete**, then press the button labelled with the letter you want to search for. A name beginning with the letter appears on the display.

For example, if you want to find the name 'MOBILE,' press the '6' button, which is labelled with 'MNO.'

2. Press **▶** to display the next name in the list, or **◀** to display the previous name.

3. When the name and number you want appear, press **Start/Enter to dial**.

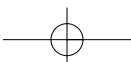

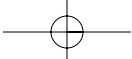

4

Advanced fax

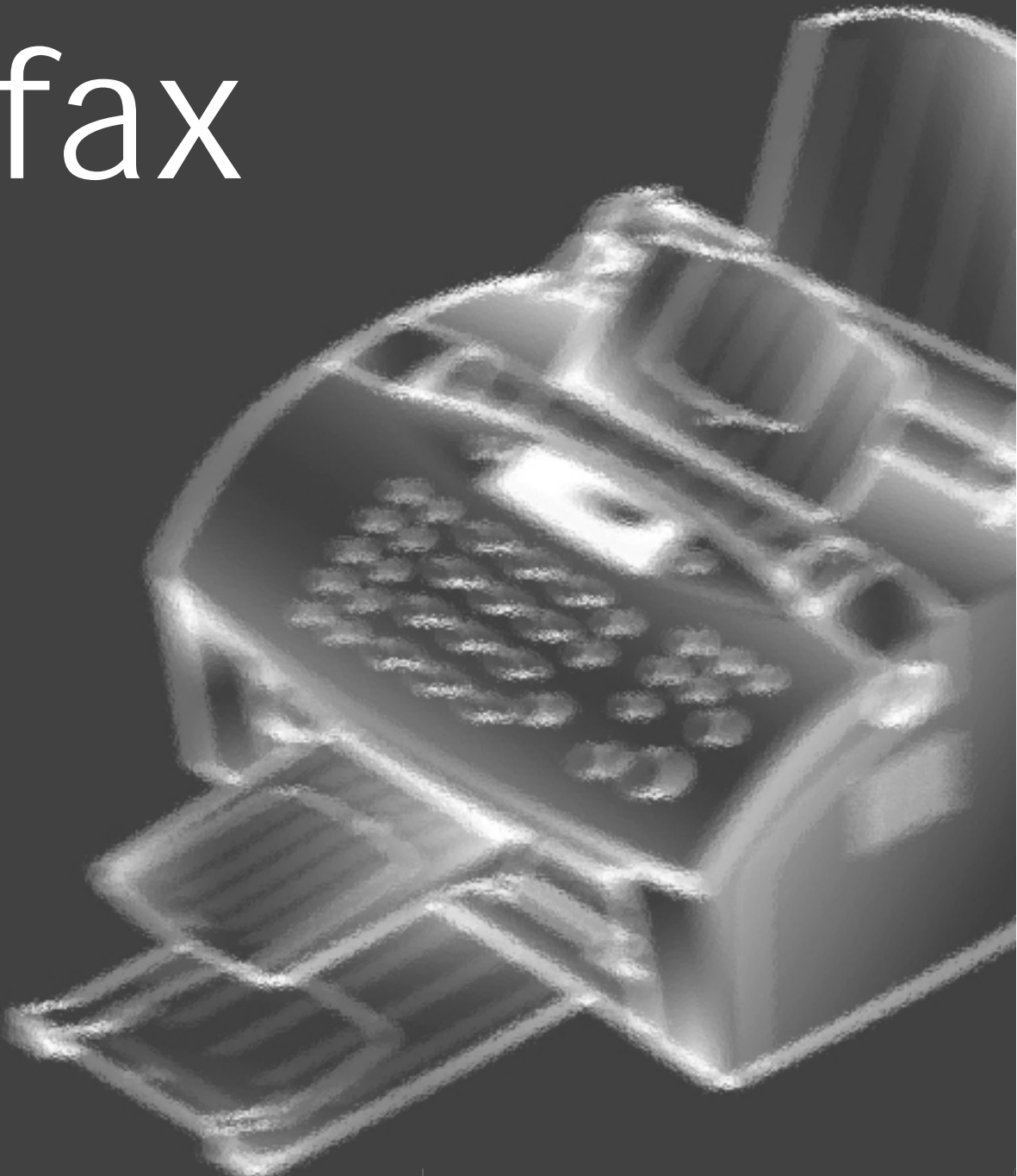

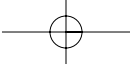

Broadcasting

Use this feature to send your documents to multiple locations. After sending, the documents are automatically erased from the memory.

1. Load the document face down. If necessary, adjust **Resolution**, or **Contrast**. For details, see page 3.2.

2. Press Advanced FAX on the control panel.

The display shows the first menu; BROADCASTING.

3. Press Start/Enter to access the broadcasting menu.

4. Enter the number of the remote machine using the number keypad.

To enter the number, you can also press a one-touch button including group dial button. Otherwise, press **Speed**, enter a 2-digit speed dial number, then press **Start/Enter**. The stored number appears on the display.

5. Press Start/Enter to confirm the number. The display asks you to enter another fax number to send the document to another location.

6. Enter another fax number using the number keypad, one-touch dial, or 2-digit speed dial number. Note that you cannot use group dial numbers for another fax number.

The number appears on the display. **Press Start/Enter to confirm the number.**

Or

To send to one location or when you complete the last fax number setting, press Start/Enter.

7. The document will be scanned into the memory before transmission. The display shows the memory capacity and the number of pages being stored in the memory, then the machine begins sending the document in order of the numbers you entered.

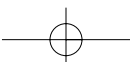

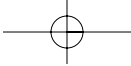

Note: If 'MEMORY FULL' occurs while scanning into the memory, the display will show:

JOB ► CANCEL ► DONE

Press ◀ or ▶ to select the option you want. If you select **CANCEL**, broadcasting is cancelled. If you select **DONE**, your machine performs broadcasting only with the pages already scanned.

If an error occurs while sending to a specific number, the machine transmits the document to all the other numbers, then retries the number that previously recorded an error. After completing transmission, your machine prints the multi-communication report.

Delayed fax

You can set your machine to send a fax at a later time when you will not be present.

- 1. Load the document face down.** If necessary, adjust **Resolution**, or **Contrast**. For details, see page 3.2.
- 2. Press Advanced FAX on the control panel.**
The display shows the first menu; BROADCASTING.
- 3. Press ◀ or ▶ until 'DELAYED FAX' appears, then press Start/Enter.**
- 4. Enter the number of the remote machine, then press Start/Enter.**

To enter the number, you can also press a one-touch button including Group dial button. Otherwise, press **Speed**, enter a 2-digit speed dial number, then press **Start/Enter**. The stored number appears on the display.

- 5. Press Start/Enter to confirm the number.** The display asks you to enter another fax number to send the document to another location.

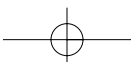

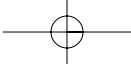

- 6. If you want to send to more than one location, enter another fax number using the number keypad, one-touch dial, or 2-digit speed dial number.** Note that you cannot use group dial numbers for another fax number.

The number appears on the display. **Press Start/Enter to confirm the number.**

Or

To send to one location or when you complete the last fax number setting, press Start/Enter.

- 7. The display asks you to enter a name. If you want to assign a name to the transmission, enter the name. If not, skip over this step.**

For details on how to enter the name using the number keypad, see page 2.3.

- 8. Press Start/Enter.** The display shows the current time and asks you to enter the time when the fax is to be sent.

TI ME (13: 30) = 13: 30

- 9. Enter the time by using the number keypad, then press Start/Enter.**

Enter the time in 24-hour format. For example, enter 2230 for 10:30 P.M. If you set a time earlier than the current time, the document will be sent at that time on the following day.

- 10. The document will be scanned into the memory before transmission.** The display shows the memory capacity and the number of pages being stored in the memory.
- 11. The machine returns to standby mode and the display alternates between messages to remind you that you are in standby mode and that delayed transmission is set.**

Note: *If you want to cancel the delayed fax, see 'Canceling a scheduled operation' on page 4.7.*

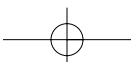

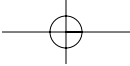

Priority fax

When the priority fax is enabled, a high priority document can be transmitted ahead of reserved operations. The document is scanned into the memory, then transmitted when the current operation is concluded. In addition, a priority transmission will interrupt a broadcast operation between stations (i.e., when transmission to station A ends, before transmission to station B begins) or between redial attempts.

1. Load the document face down. If necessary, adjust **Resolution**, or **Contrast**. For details, see page 3.2.

2. Press Advanced FAX on the control panel.

The display shows the first menu; BROADCASTING.

3. Press ◀ or ▶ until 'PRIORITY FAX' appears, then press Start/Enter.

4. Enter the number of the remote machine, then press Start/Enter.

To enter the number you can also press a one-touch button including group dial button. Otherwise, press **Speed**, enter a 2-digit speed dial number, then press **Start/Enter**. The stored number appears on the display.

5. Press Start/Enter to confirm the number. The display asks you to enter a name.

6. If you want to assign a name to the transmission, enter the name. If not, skip over this step.

For details on how to enter a name using the number keypad, see page 2.3.

7. Press Start/Enter. The document will be scanned into the memory before transmission. The display shows the memory capacity and the number of pages being stored in the memory.

8. The machine shows the number being dialled, then begins sending the document.

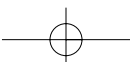

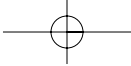

Polling

What is polling?

Polling is used when one fax machine requests another to send a document. This is useful when the person with the original document to be sent is not in the office. The person who wants to receive the document calls the machine holding the original and requests that the document be sent. In other words, it “polls” the machine holding the original.

Send polling

You can programme your fax machine to send documents in your absence when polled by a remote fax machine. It is possible to use a poll code to prevent unauthorized polling of your fax machine. When you secure your machine in this manner, only those who know the poll code can poll your machine.

- 1. Load the document face down.** If necessary, use **Resolution**, or **Contrast**. For details, see page 3.2.
- 2. Press Advanced FAX on the control panel.**
The display shows the first menu; BROADCASTING.
- 3. Press ◀ or ▶ until ‘SEND POLLING’ appears, and press Start/Enter.**
4. The display asks you to enter a 4-digit poll code. The poll code is preset to 0000 at the factory, which represents no poll code.

POLLCODE [0000]

- 5. If you want to use a poll code, enter the 4-digit code (except for 0000), then press Start/Enter. Or**

If you do not want to secure the transmission with a poll code, press Start/Enter when the display shows 0000 for the poll code, or press 0000.

6. The display asks you to store the document in the machine’s bulletin memory.

If you store the document in the bulletin board memory, more than one remote station can poll that document from your machine. If not, the document will be automatically erased after being polled by a remote machine.

Press ◀ or ▶ to select YES or NO.

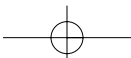

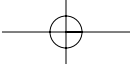

7. The machine stores the document in the memory. The display counts the number of pages being stored in the memory and the memory capacity remaining.

The machine returns to standby mode and the display shows a reminder that a send polling is set. The machine automatically switches to FAX mode (automatic receiving) when set to be polled.

Receive polling

You can set your machine to automatically receive documents from one or more unattended remote fax machines. This feature permits unattended polling in the evening hours when telephone rates are lower.

Note: The remote machine must be ready for polling.

1. **Call the remote fax machine.**

2. **When you hear the fax tone, press Advanced FAX.** The display shows 'RECEIVE POLLING?'

3. **Press Start/Enter.** The display asks you to enter a 4-digit code. Poll code '0000' represents no code.

POLLCODE [0000]

4. **If the remote machine is secured with a poll code, you must enter the correct code, and press Start/Enter.**

Or

If the remote machine is not secured with a poll code, press Start/Enter to accept [0000] which represents no code.

5. The machine begins to receive polling.

Note:

- *If you want to cancel the operation, press **Stop** at any time.*
- *Not all fax machines have polling capability, and polling incompatibility sometimes occurs between fax machines from different manufacturers.*

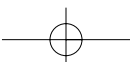

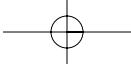

Adding documents to a scheduled operation

You can add documents to the delayed transmission previously reserved in your machine's memory.

- 1. Load the document face down.** If necessary, adjust **Resolution**, or **Contrast**. For details, see page 3.2.
- 2. Press Advanced FAX on the control panel.**
The display shows the first menu; BROADCASTING.
- 3. Press ◀ or ▶ until 'ADD SCHEDULE' appears, then press Start/Enter.** The display shows the operation, time and number currently reserved in the memory.
- 4. Press ◀ or ▶ repeatedly until you find the operation to which you want to add documents, then press Start/Enter.**

The machine automatically stores the documents in the memory, and the display shows the memory capacity and the number of pages.

- 5. After storing, the machine displays the number of total pages, then returns to Standby mode.**

Canceling a scheduled operation

- 1. Press Advanced FAX on the control panel.**
The display shows the first menu; BROADCASTING.
- 2. Press ◀ or ▶ until you find 'CANCEL SCHEDULE', then press Start/Enter.**
- 3. Press ◀ or ▶ repeatedly until you find the operation you want to cancel, then press Start/Enter.** The display asks you to confirm your selection.
- 4. Press Start/Enter to cancel the operation.**

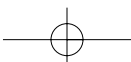

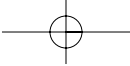

5

Additional features



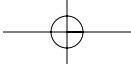

Printing reports

Your machine can print reports containing useful information – Schedule Job, System Data, etc. The following reports are available:

Help List

This list shows the machine's basic functions and commands to use as a quick reference guide.

Sent Journal

This report shows information concerning transmission activities recently made.

Received Journal

This report shows information concerning reception activities recently made.

Phonebook List

This list shows all of the numbers currently stored in the machine's memory as one-touch dial numbers, speed dial numbers, and group dial numbers.

Sending Confirmation

This report shows the fax number, the number of pages, elapsed time of the operation, the communication mode, and the communication results.

You can set up your machine to print the message confirmation report in one of the following ways (see page 5.3):

- Automatically after each transmission (ON)
- Automatically only if an error occurs during transmission (ERR)
- No report printed at all (OFF). You can print this report manually at any time you want.

Schedule Information

This list shows the document currently stored for delayed transmission, priority transmission, broadcasting, and send polling. The list shows the starting time, type of operation, etc.

System Data List

This list shows the status of the user-selectable options. After you change any setting, print this list to confirm your changes.

Multi-Communication Report

This report is printed automatically after sending documents to or receiving documents from more than one location.

Call Back Message

This report is printed automatically when you do not respond to a remote operator's voice request.

Power Failure Report

This report is printed automatically when power is restored after a power failure. This report shows data (if any) erased by the power failure.

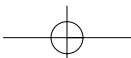

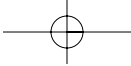

Note: *The list you have set to print out automatically will not print out when there is no paper loaded or a paper jam has occurred.*

To print list

- 1. Press Report/Help on the control panel.** The display shows the first menu; HELP.
- 2. Press ◀ or ▶ until you find the list you want to print, then press Start/Enter.** The selected list will be printed out.

System setup

Your machine has various user-selectable system options. These options are preset at the factory, but you may need to change them. To find out how the options are currently set, print the system data list. For more information on printing the list, see above.

Setting an option

- 1. Press Setup on the control panel.** The display shows the first menu: FAX NUMBER/NAME.
- 2. Press ◀ or ▶ until 'SYSTEM SETUP' appears, then press Start/Enter.** The display shows the first option menu; LANGUAGE.
- 3. Scroll through the options by pressing ◀ or ▶ repeatedly.**
- 4. When the option you want appears on the display, press Start/Enter.**
- 5. Choose the desired status by pressing ◀ or ▶ repeatedly, or enter the desired value using the number keypad.**
- 6. When the desired status appears, press Start/Enter.**
- 7. You can exit from setup mode at any time by pressing Stop.** When you press **Stop**, the machine stores the options you have already changed and returns to standby mode.

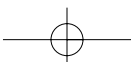

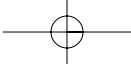

Selectable options

These instructions assume that you have followed the steps on page 5.2 under 'Setting an option' and the machine is prompting you to change one of the options listed here.

- **LANGUAGE** — You can select the display language from English, German, French, Italian, Spanish, Portuguese and Dutch.

- **SEND FROM MEMORY** — This feature enables all transmission documents to be automatically scanned into the memory before transmission.

Select **ON** to turn this feature on.
Select **OFF** to turn this feature off.

- **SENDING CONFIRM** — A confirmation report shows whether the transmission was successful or not, how many pages were sent, etc.

Select **ON** to print a confirmation report automatically each time you send a fax.

Select **OFF** to turn this feature off.

Select **ERROR** to print only when an error occurs and the transmission was not successful.

- **FAX PAPER SIZE** — Select the paper size you will use for the recording paper. LETTER, A4 and LEGAL size are available.

- **TONER SAVE MODE** — You can preserve the toner supply with this mode.

Select **ON** to turn this feature on. The machine prints documents using less toner. The print quality may be reduced.

Select **OFF** to turn this feature off.

- **POWER SAVE MODE** — The power saving menu item lets you reduce power usage when the printer is idle.

Select the desired time to turn this feature on. The time you choose determines the length of time the printer waits after a job is printed before it switches to a reduced power state.

Select **OFF** to turn this feature off. It keeps the printer ready to print with minimum warm-up time.

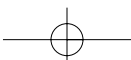

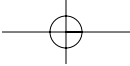

- **AUTO REDUCTION** — When receiving a document as long as or longer than the paper loaded in your machine, the machine can reduce the data in the document to fit into your recording paper size.

Turn on this feature if you want to reduce an incoming page that may otherwise need to be divided into two pages with only a few centimeters on the second page. If the fax machine cannot reduce the data to fit onto one page with this feature enabled, the data will be divided and printed in actual size on two or more sheets if needed.

Select **ON** to turn this feature on. Note that this feature does not apply to the copy mode.

Select **OFF** to turn this feature off. The overflow data will be printed out on a second page.

- **DISCARD SIZE** — When receiving or copying a document as long as or longer than the paper installed in your machine, you can set the machine to discard any excess image at the bottom of the page to fit onto the recording paper size.

Enter the desired discard size from 0 through 30 mm using the number keypad, and press **Start/Enter**.

If the received page is outside the margin you have set, it will be printed on two sheets of paper at the actual size.

If the data is within the margin, and the auto reduction feature is turned on, it will be reduced to fit onto the appropriate size paper (Discard does not take place). If the auto reduction feature is turned OFF or fails, the data within the margin will be discarded.

- **RINGS TO ANSWER** — You can select the number of times your machine rings before answering an incoming call. If you are using your machine as both a telephone and a fax machine, we suggest you set the ring count to at least 4 to give you time to answer.
- **STAMP RCV. NAME** — This feature allows the machine to automatically print the page number, and the date and time of the reception at the bottom of each page of a received document.

Select **ON** to turn this feature on.
Select **OFF** to turn this feature off.

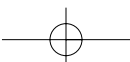

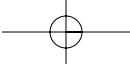

- **RCV. START CODE** — The remote receive start code allows you to initiate fax reception from an extension phone plugged into the EXT. jack on the back of your machine. If you pick up the extension phone and hear fax tones, enter the remote code and the machine will start receiving. The password is preset to * 9 * at the factory.

Enter the desired code 0 to 9 on the number keypad.

- **ECM MODE (Error Correction Mode)** — This mode compensates for poor line quality and ensures accurate, error-free transmission with any other ECM-equipped facsimile machine. If the line quality is poor, transmission time may be increased when the ECM is enabled.

Select **ON** to turn the error correction mode on.
Select **OFF** to turn the error correction mode off.

- **CALLER ID** — When you receive a call, you can see the number of the person calling you if it is available from the network on which the call was made. (This option may not work when connected to a PABX.)

Select **ON** to turn on caller ID display.
Select **OFF** to disable.

- **JUNK FAX BARRIER** — With this feature set to ON, the system will only accept a fax sent from the remote station of which the fax number is stored in memory as a one-touch or two-digit speed dial number. This feature is useful for blocking any unwanted fax.

Select **ON** to turn this feature on. You can receive only from the registered stations.
Select **OFF** to turn this feature off. Anybody can send you a fax.

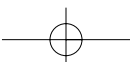

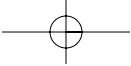

- **Distinctive Ring Pattern Detection (DRPD)**— “Distinctive ring” is a telephone company service which enables a user to use a single telephone line to answer several different telephone numbers. The particular number someone uses to call you on is identified by different ringing patterns, which consist of various combinations of long and short ringing sounds. This feature is often used by answering services who answer telephones for many different clients and need to know which number someone is calling in on to properly answer the phone.

Using the *distinctive ring pattern detection* feature, your fax machine can “learn” the ring pattern you designate to be answered by the FAX machine. Unless you change it, this ringing pattern will continue to be recognised and answered as a FAX call, and all other ringing patterns will be forwarded to the extension telephone or answering machine plugged into the EXT. jack.

You can easily suspend or change distinctive ring pattern detection at any time.

Before using the *distinctive ring pattern detection* option, distinctive ring service must be installed on your telephone line by the telephone company. To setup *distinctive ring pattern detection*, you will need another telephone line at your location, or someone available to dial your FAX number from outside.

Select **ON** to turn this feature on.

Select **OFF** to turn this feature off.

Select **SET** to setup or change the *distinctive ring pattern detection*.

The LCD displays [WAITING RING]. Call your fax number from another telephone. It is not necessary to place the call from a fax machine. When your machine begins to ring, do not answer the call. The machine requires several rings to learn the pattern.

When the machine completes learning, the LCD displays ‘END DRPD SETUP’.

With the distinctive ring pattern detection feature active, ‘distinctive ring pattern detection’ appears in the display and the previously set reception mode is ignored. If you turn off distinctive ring pattern detection, the machine returns to any previously set reception mode.

Notes:

- *Distinctive ring pattern detection must be set up again if you re-assign your fax number, or connect the machine to another telephone line.*
- *After distinctive ring pattern detection has been set up, call your fax number again to verify that the machine answers with a fax tone. Then have a call placed to a different number assigned to that same line to be sure the call is forwarded to the extension telephone or answering machine plugged into the EXT. jack.*

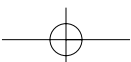

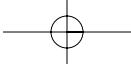

Group dialing (for multi-address transmission)

Numerous one-touch and speed dial numbers can be registered as a group. By using the group number, you can send a document to multiple parties in a single operation. Your machine will dial the remote numbers in stored sequence. If the number is busy, your machine will dial the next stored number and after dialing all of the stored numbers, will automatically redial any number that was previously busy. Before you can use this feature, you must coordinate and store the group numbers desired.

Storing one-touch or speed dial numbers for group dialing

1. Press Setup on the control panel.

The display shows the first menu; FAX NUMBER/NAME.

2. Press ◀ or ▶ until you find 'GROUP DIAL SETUP', then press Start/Enter.

3. Press one of ten one-touch buttons (1 through 10) that you want to use for group dial.

4. The display asks you to confirm that you use this button for group dialing. Press Start/Enter.

Note: If a number has already been stored in the location you chose, the display shows 'Txx USED!'. Then you are allowed to select 'OTHER' or 'RENEW' by pressing ◀ or ▶. Select 'OTHER' to start over with a different location, or 'RENEW' to replace that number and continue.

5. The display asks you to press a one-touch button or to enter a 2-digit speed dial number that you wish to include in the group.

6. Press a one-touch button where the fax number you wish to include in the group is stored.

Or

Enter a 2-digit speed dial location where the fax number you wish to include in the group is stored.

7. Press Start/Enter. Repeat step 6 to enter more destination numbers into the selected group.

8. Press Start/Enter when you have entered all the desired destinations. The display asks you to enter a name.

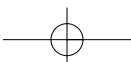

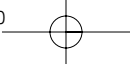

9. To assign a name to the group, enter the desired name.

Or

If you do not want to assign a name, skip this procedure.

10. When you are finished, press Stop.

Note: You cannot include one group dial number in another group dial number.

Editing group dial numbers

You can edit one-touch or speed dial numbers stored for group dialing.

1. Press Setup on the control panel.

The display shows the first menu; FAX NUMBER/NAME.

2. Press ◀ or ▶ until you find 'GROUP DIAL SETUP', then press Start/Enter.

3. Press the one-touch group dial button used for the group dial number you want to edit.

4. Press ◀ or ▶ to select the option you want, then press Start/Enter.

Select ▶ **MEMBER ADD** to add a number, and enter as many numbers as needed. To stop entering numbers, press **Stop**. Note that you cannot include one group number in another group dial number.

Select ▶ **MEMBER DELETE** to delete a number. When the number that you want to delete is displayed, press **Start/Enter**.

5. When you are finished, press Stop.

Sending a fax using group dialing (Multi-address transmission)

You can use group dialing for broadcasting or delayed fax.

Follow the procedure of the desired operation (Broadcasting - p. 4.1, Delayed fax - p. 4.2). When you come to a step in which the display requests you to enter the remote fax number, press the one-touch button where you stored the group number. You can use only one group number for one operation. Then continue the procedure to complete the desired operation.

Your machine automatically scans the document loaded in the document tray into the memory, and the machine will dial each of the numbers included in the group.

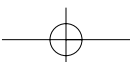

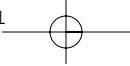

Clearing memory

You can selectively clear information stored in your machine's memory.

- 1. Press Setup on the control panel.** The display shows the first menu; FAX NUMBER/NAME.
- 2. Press ◀ or ▶ until 'MEMORY CLEAR' appears, then press Start/Enter.** The display shows the items you can choose to clear.
 - FAX NUMBER/NAME : your fax number and name are cleared from the machine's memory.
 - DIAL/SCHEDULE : clears the one-touch, speed dial, or group dial numbers stored in the memory. In addition, all the schedule job operations you have reserved are also cancelled.
 - JOURNAL : clears all records of transmissions & receptions.
 - DEFAULT SETUP : restores all the option settings to factory default.
- 3. Press ◀ or ▶ until you find the item you want to clear, then press Start/Enter.** The display asks you to confirm your selection.
- 4. Press Start/Enter to confirm.** The selected memory is cleared, then the display asks you to continue clearing the next item.
- 5. Repeat steps 3 and 4 to clear another item. To exit, press Stop.**

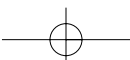

6

Troubleshooting



Troubleshooting



Clearing jams

Document jams while sending a fax

If a document jams while you are sending it, 'DOCUMENT JAM' appears on the display. **Do not pull the document out of the slot. If you do this, it could harm your machine.**

1. Open the control panel using your hand.

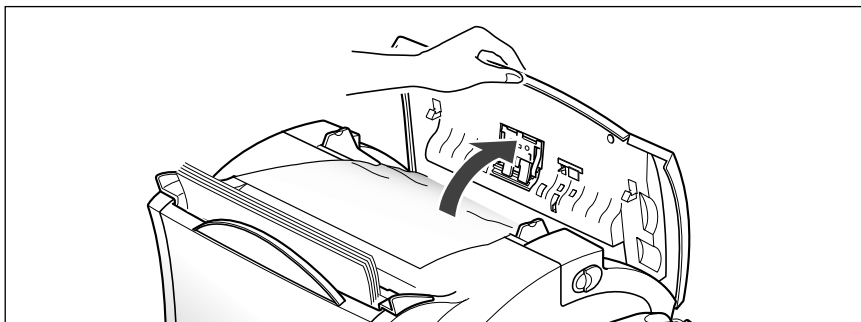

2. Carefully remove the jammed document. Then close the control panel firmly until it clicks into place.

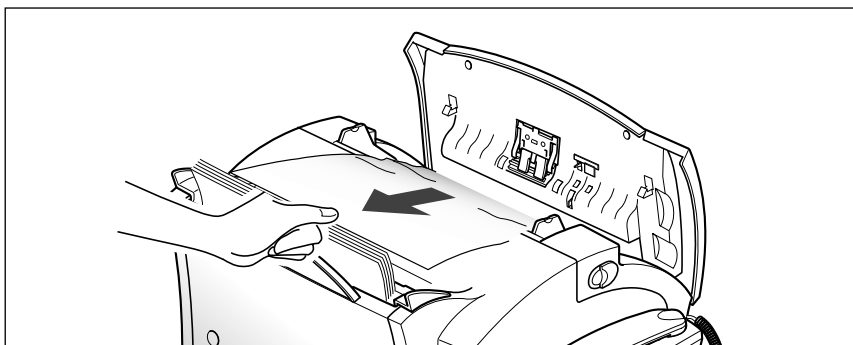

Paper jams while the machine is printing

By carefully selecting the paper type and loading them properly, you should be able to avoid most paper jams. If paper jams occur, an error message appears on the display. Follow the steps below to clear the jam. To avoid tearing the paper, pull the jammed paper out gently and slowly.

IF JAMMED IN THE PAPER FEED AREA

1. Remove the jammed paper as shown below.

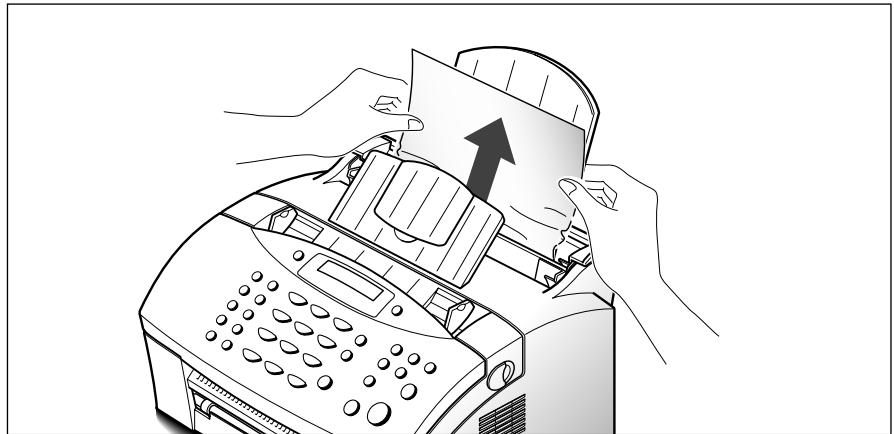

2. After you have removed the jammed paper, load the paper with the print side facing you.

Adjust the paper guides to match the width of the paper.

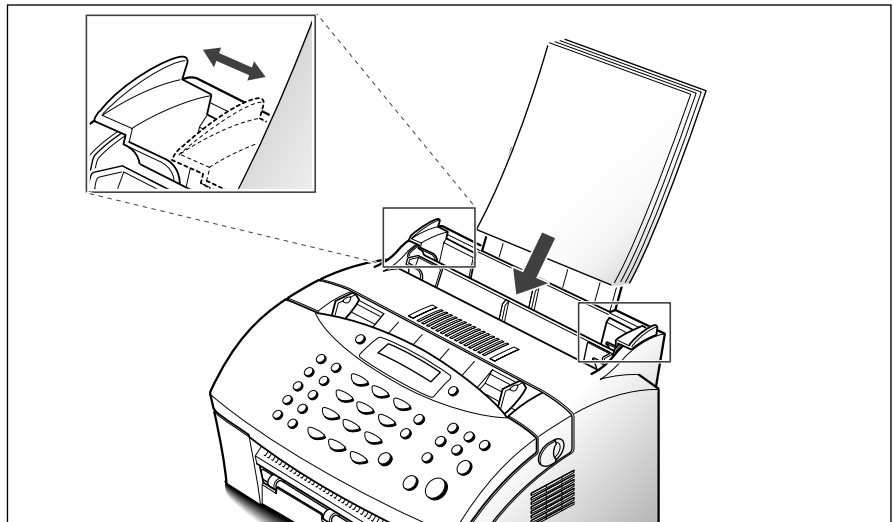

IF JAMMED IN THE PRINTER OUTPUT AREA

- 1. If the paper jams as it exits to the paper exit tray and a long portion of the paper is visible, pull the paper straight out.**

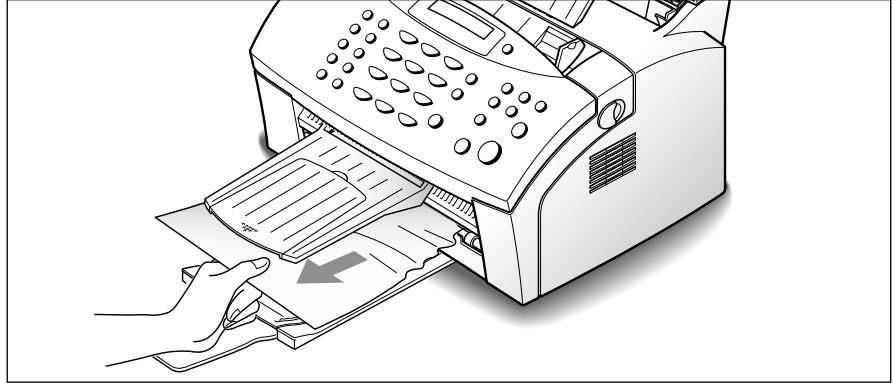

If there is any resistance, and the paper does not move immediately when you pull, stop pulling. Continue with the next step.

IF JAMMED INSIDE THE MACHINE

- 1. Pulling the cover release buttons toward you, open the cover.**

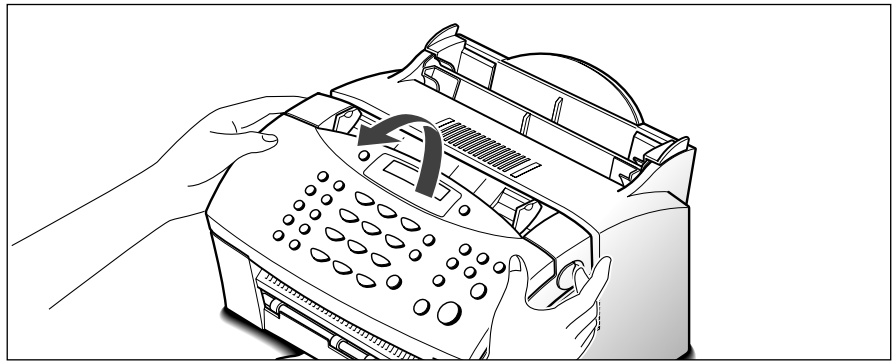

- 2. Remove the toner cartridge.**

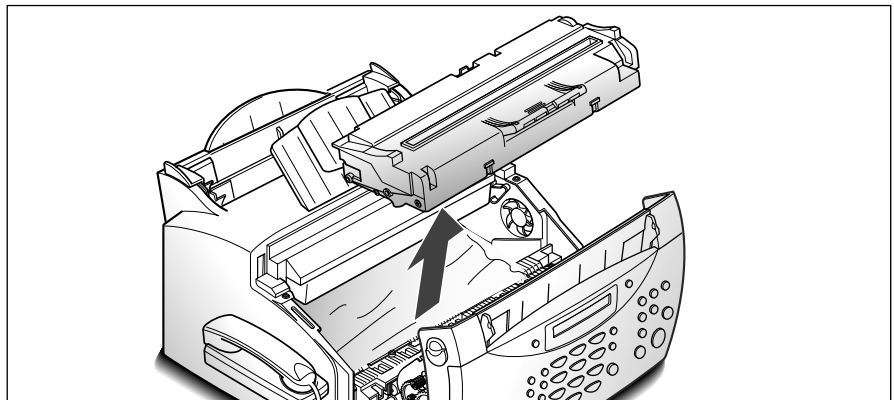

3. Gently pull the paper toward you.

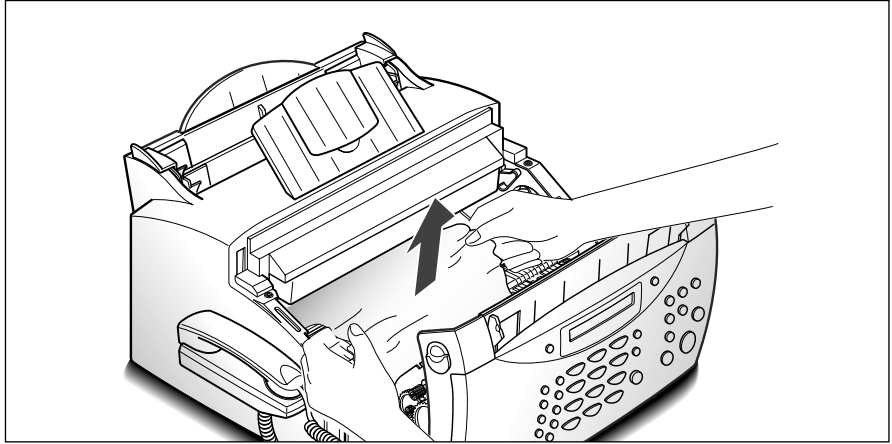

4. Check that there is no other paper in the printer.

5. Reinstall the cartridge, then close the cover.

Tips for avoiding paper jams

By carefully selecting print materials and loading them properly, you should be able to avoid most paper jams. If jams do occur, follow the steps outlined in “Clearing jams” starting on page 6.1. If jams occur frequently, make sure that you are following these preventative tips:

- Follow the procedures in “Loading paper” on page 1.10 to load paper properly. Make sure that the adjustable guides are positioned correctly.
- Do not overload the paper. Up to 150 sheets can be loaded at a time.
- Flex, fan, and straighten the paper before loading it.
- Do not load wrinkled, creased, damp, or highly curled paper.
- Do not mix paper sizes.
- Use only recommended print materials.
- Make sure that the recommended print side is facing up when loading it in the feeder.
- Keep print materials stored in a suitable environment.

LCD error messages

Display	Meaning	Solution
DOCUMENT JAM	The loaded document has jammed in the feeder.	Clear the document jam.
DOOR OPEN	The top cover is not securely latched.	Press down on the cover until it clicks in place.
FUSER ERROR	There is a problem in the fuser unit.	Unplug the power cord and plug it back in. If the problem still persists, please call for service.
JAM/NO CARTRIDGE	Recording paper has jammed inside the unit, or the toner cartridge is not installed.	Clear the jam, or install the cartridge.
LINE ERROR	Your unit cannot connect with the remote machine, or has lost contact because of a problem on the phone line.	Try again. If failure persists, wait an hour or so for the line to clear, then try again. Or, turn the ECM mode on. See 'System setup' on page 5.5.
LOAD DOCUMENT !	You have attempted to set up a sending operation with no document loaded.	Load a document and try again.
LSU ERROR	A problem has occurred in the LSU (Laser Scanning Unit).	Unplug the power cord and plug it back in. If the problem still persists, please call for service.
MEMORY FULL	The memory is full.	Either delete unnecessary documents, or retransmit after more memory becomes available, or split the transmission into more than one operation.
NO ANSWER	The remote machine has not answered after all the redial attempts.	Try again. Make sure the remote machine is operational.
NO. NOT ASSIGNED	The one-touch or speed dial location you tried to use has no number assigned to it.	Dial the number manually with the keypad, or assign a number.
NO PAPER	The recording paper has run out.	Load the recording paper.
OVER HEAT	The printer part in your unit has overheated.	Please wait until it cools down. If you cannot solve the problem, please call for service.

Display	Meaning	Solution
PAPER JAM 0	Recording paper has jammed in the paper feeding area.	Press Stop and clear the jam.
PAPER JAM 2	Jammed paper still remains inside the unit.	Clear the jam.
POLLING ERROR	The remote fax machine you want to poll is not ready to respond to your poll. Or When setting up to poll another fax machine, you have used an incorrect poll code.	The remote operator should know in advance that you are polling and have their fax unit loaded with the original document. Enter the correct poll code.
POWER FAILURE	A power failure has occurred.	If documents have been stored in the memory, a 'Power Failure Report' will be printed automatically when the power is restored.
RECEIVE ERROR	A fax has not been received successfully.	A problem with the facsimile communications has occurred. Ask the sender to try again.
RETRY REDIAL ?	The machine is waiting for a specified time interval to redial a previously busy station.	You can press Start/Enter to immediately redial, or Stop to cancel the redial operation.
SEND ERROR	Your fax has not gone through successfully.	A problem with the facsimile communications has occurred. Try again.
TONER EMPTY	The toner cartridge has run out. The machine stops.	Replace with a new toner cartridge.
TONER LOW	The toner is almost empty.	Take out the toner cartridge and gently shake it. By doing this, you can temporarily re-establish printing operations.
WARMING UP	The printer is warming up and is off-line.	Wait until the printer is on-line.

Fixing problems

Your problem may be listed on page 6.5 in the 'LCD error messages' section. Below are the other problems you can solve by yourself. If not, call for service.

Symptom	Cause and Solution
The machine is not working, there is no display and the buttons are not working.	<ul style="list-style-type: none"> • Unplug the power cord and plug it in again. • Check that your socket is active.
No dial tone.	<ul style="list-style-type: none"> • Check that the phone line is connected properly. • Check that the phone socket in the wall by plugging in another phone.
The numbers stored in the memory do not dial correctly.	<ul style="list-style-type: none"> • Make sure that the numbers are stored in the memory correctly. • Print a phonebook list. See page 5.1.
The document does not feed into the machine.	<ul style="list-style-type: none"> • Make sure that the document is not wrinkled and you are putting it in correctly. Check the document is the right size, not too thick or thin. • Make sure that the cover is firmly closed.
You cannot receive faxes automatically.	<ul style="list-style-type: none"> • The FAX or AUTO mode should be selected. • Is there paper in the machine? • Check if the display shows 'MEMORY FULL.'
The machine cannot receive faxes manually.	<ul style="list-style-type: none"> • Did you hang up the handset before you pressed Start/Enter?
The machine will not send anything.	<ul style="list-style-type: none"> • Make sure that the document is loaded face down. • 'TX' should show up on the display. • You may have hung up the handset (if you lift it up) before you pressed Start/Enter. • Check the other machine you are sending to, to see if it can receive your fax.



Symptom	Cause and Solution
You cannot poll another machine.	<ul style="list-style-type: none"> • The fax machine you are polling may be using a poll code.
The incoming fax has blank spaces or you received a poor-quality copy.	<ul style="list-style-type: none"> • The machine sending you the fax may be faulty. • The fax machine sending you a fax may have a dirty scan glass. • A noisy phone line can cause line errors. • Check your machine by making a copy. • The cartridge toner may be empty.
Are some of the words on the incoming fax stretched?	<ul style="list-style-type: none"> • The machine sending you the fax had a temporary document jam.
There are lines on the copies or documents you send.	<ul style="list-style-type: none"> • Check your scan glass for marks, and clean it. See page 6.11.
The machine dials a number, but fails to make a connection with another fax machine.	<ul style="list-style-type: none"> • The other fax machine may be turned off, out of paper, or cannot answer incoming calls. Speak with the other machine operator and ask them to sort out the problem.
You cannot store a document in the memory.	<ul style="list-style-type: none"> • There may not be enough memory to store the document. If the display shows a 'MEMORY FULL' message, delete any documents you no longer need from the memory, then restore the document.
Blank areas appear at the bottom of each page or on other pages, with only a small strip of text printed at the top.	<ul style="list-style-type: none"> • You may have chosen the wrong paper settings in the user options set up. See page 5.3 to choose a proper paper size.

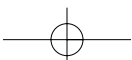

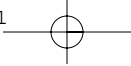

Maintenance

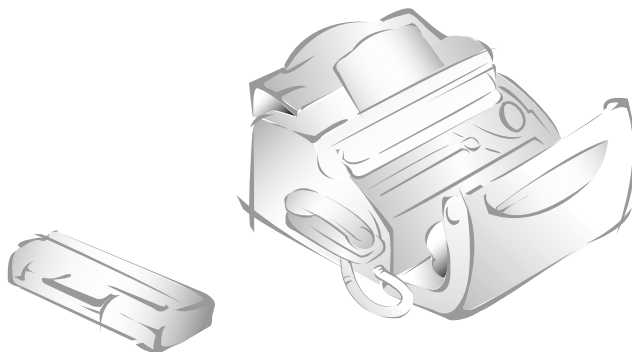

Cleaning the OPC drum

If you are getting streaks or spots on your print, you may clean the OPC drum.

- 1. Make sure that the paper is loaded.**
- 2. Press Setup on the control panel.**
The display shows the first setup menu; FAX NUMBER/NAME.
- 3. Press ◀ or ▶ until 'MAINTENANCE' appears, then press Start/Enter.**
- 4. Press ◀ or ▶ until you find 'CLEAN DRUM', then press Start/Enter.**

The machine automatically pulls in a sheet of paper, and prints it out.
The toner particles on the OPC drum surface are fixed to the paper.
- 5. Press Stop to return to standby mode.**

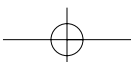

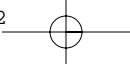

Adjusting shading

When the scanning unit gets dirty, it might alter the shading value. If your print has black lines or is blurred, adjusting the shading may solve the problem. Take the following steps:

- 1. Load a sheet of white paper into the document feeder.**
- 2. Press Setup on the control panel.**
The display shows the first setup menu; FAX NUMBER/NAME.
- 3. Press ◀ or ▶ until 'MAINTENANCE' appears, then press Start/Enter.**
- 4. Press ◀ or ▶ until you find 'ADJUST SHADING', then press Start/Enter.**

Setting the machine to be checked by phone

The remote test feature allows your machine to be checked out by a service company at a remote place by phone.

- 1. Press Setup on the control panel.**
The display shows the first setup menu; FAX NUMBER/NAME.
- 2. Press ◀ or ▶ until 'MAINTENANCE' appears, then press Start/Enter.**
- 3. Press ◀ or ▶ until you find 'REMOTE TEST', then press Start/Enter.**
- 4. Press ◀ or ▶ to turn this feature ON or OFF, then press Start/Enter.**

If you want to protect your machine from being opened by an unauthorized person, select **OFF**.

- 5. Press Stop to return to standby mode.**

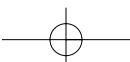

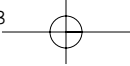

Sending toner low information to the service company

If you have set this *notify toner low* menu option to ON, when the toner cartridge needs to be replaced, your machine automatically sends a fax to your service company or the dealer to notify them that your machine requires a new toner cartridge. This feature will be activated only when the phone number of the service company or the dealer is stored in your machine's memory by technician. Ask your dealer for more information.

1. Press **Setup**, then press ◀ or ▶ until '**MAINTENANCE**' appears, and press **Start/Enter**.
2. Press ◀ or ▶ until you find '**NOTIFY TONER LOW**', then press **Start/Enter**.
3. Press ◀ or ▶ to turn this feature **ON** or **OFF**, then press **Start/Enter**.
4. Press **Stop** to return to standby mode.

Cleaning the document scanner

To keep your machine working properly, occasionally clean the white roller, ADF rubber, and the scanning glass. If they are dirty, documents sent to another fax machine will not be clear.

Note: Do not turn the power off to clean the scanner, as documents stored in the memory will be lost.

1. Open the control panel using your hand.

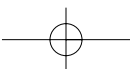
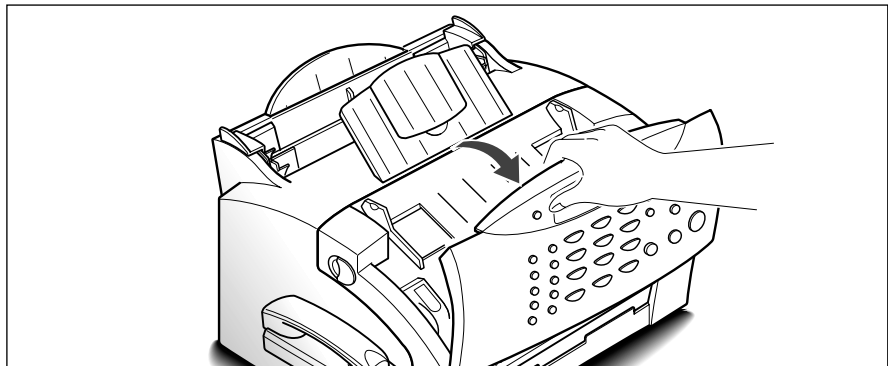

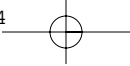

2. Disassemble the white roller as follows:

Both ends of the white roller have plastic bushings that are snapped shut with small tabs on them. Pull the bushing slightly inward, then rotate the bushing until it reaches a slot (A) . Then pull the roller upward (B) .

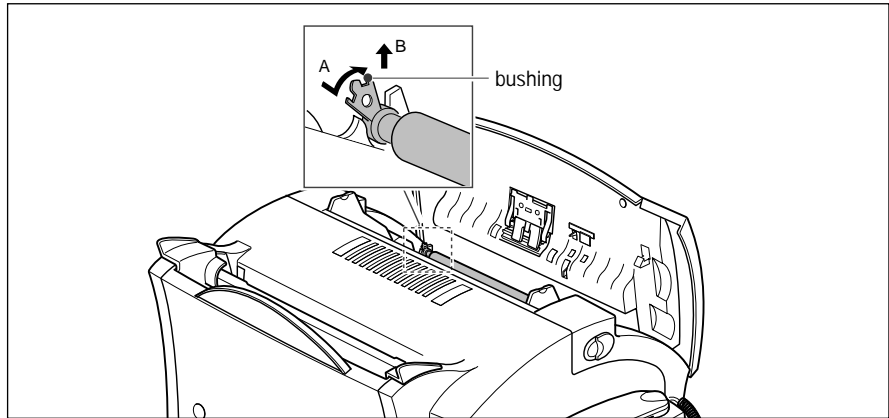

3. Wipe the roller surface with a soft cloth dampened with water.

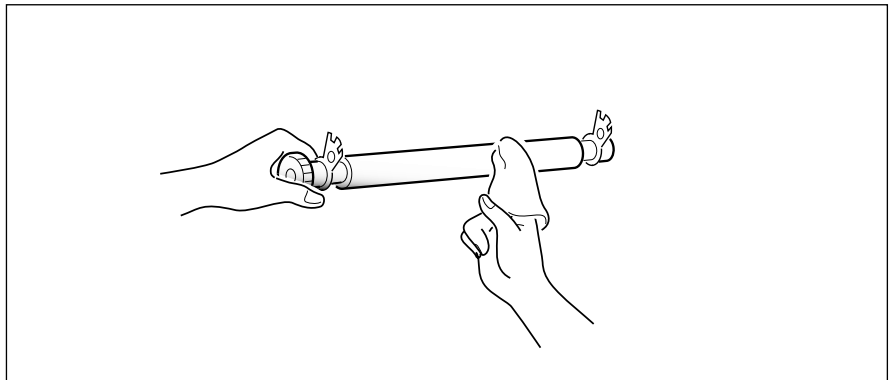

4. Clean the ADF rubber piece also.

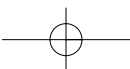
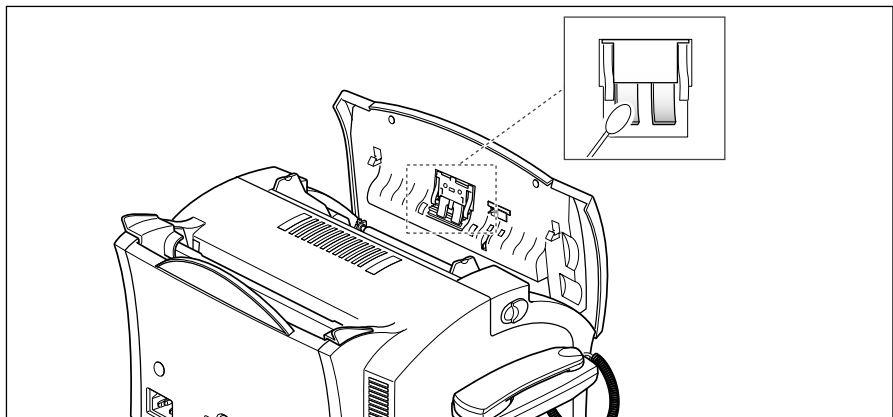

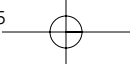

5. Carefully wipe the scanning glass with a soft, dry cloth.

If the glass is very dirty, first wipe it with a slightly dampened cloth, then with a dry cloth. Be very careful not to scratch the glass surface.

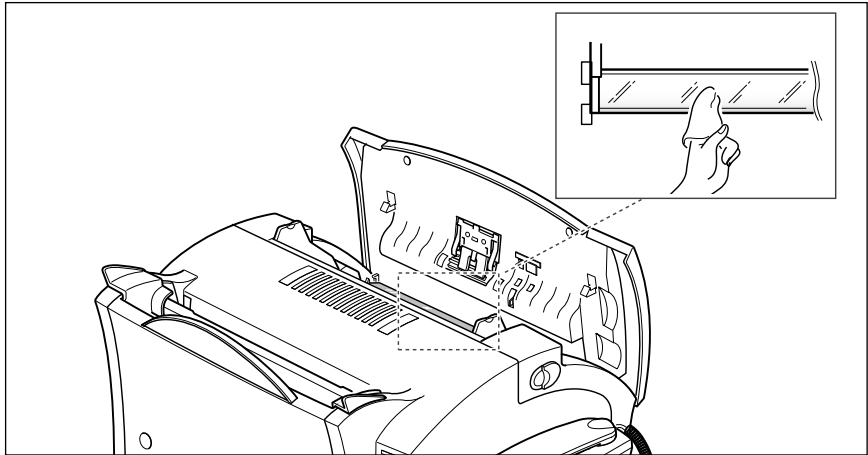

6. Replace the roller in reverse order, and then close the control panel firmly until it clicks into place.

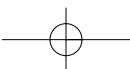
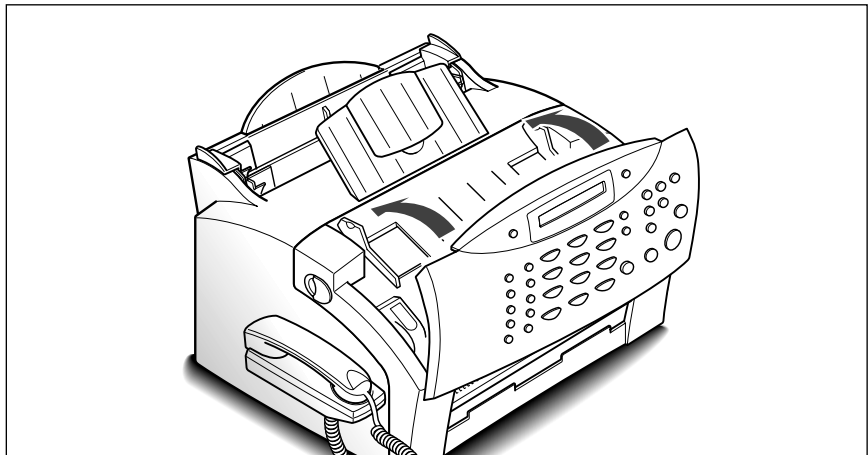

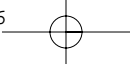

Managing the toner cartridge

Expected cartridge life

The life of your toner cartridge depends on the amount of toner used in each print job. For instance, when you print a typical business letter with about 5% page coverage, you can expect a toner cartridge life of approximately 2,500 pages (1,000 pages only for the toner cartridge shipped with your machine). The actual number may vary according to the print density of the page you print. If you print a lot of graphics, you may need to change the cartridge more often.

You can extend the life of your toner cartridge by using toner save mode (see page 5.3). The toner save mode uses less toner than normal printing. The printed image is much lighter, and is adequate for printing drafts or proofs.

Replacing the toner cartridge

When the toner cartridge is near the end of its life, white streaks or hue changes will occur. You can temporarily re-establish the print quality by re-distributing the remaining toner in the cartridge.

- 1. Open the cover and remove the toner cartridge.**
- 2. Gently shake the cartridge to distribute the toner evenly inside the cartridge.**

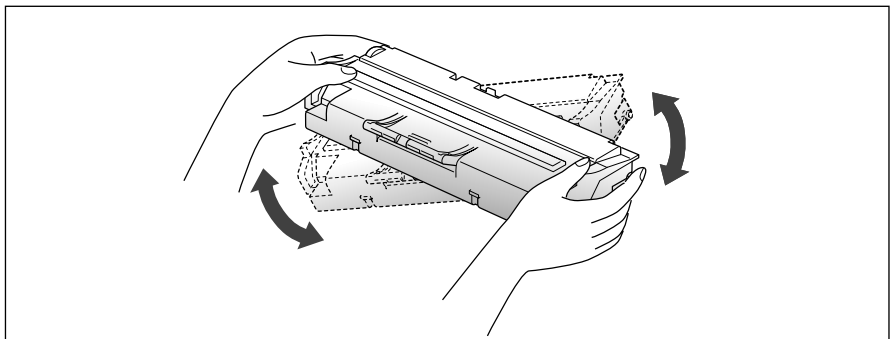

- 3. Reinstall the cartridge and close the cover.**

This is typically successful one time only. When the toner eventually runs out, only blank pages will print when a print job is sent, or when a fax is received. At this stage, the toner cartridge needs to be replaced. See the following page.

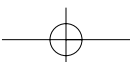

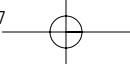

Take the following steps to replace the toner cartridge:

1. Pulling the cover release buttons toward you, open the cover.



2. Remove the old toner cartridge. Follow the instructions printed on the cartridge box to recycle the used cartridge.

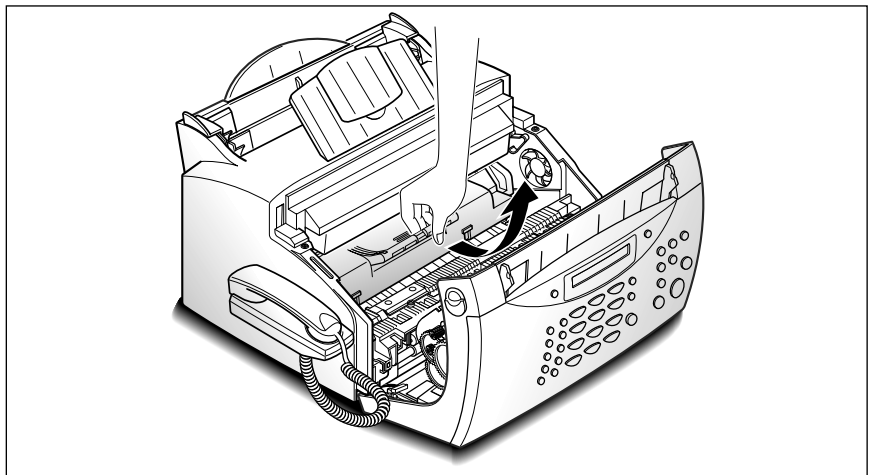

3. Unpack the cartridge from its plastic bag, and then remove the paper rolled the cartridge. Holding on each end of the paper, pull it straight out, and then carefully remove it.

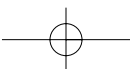
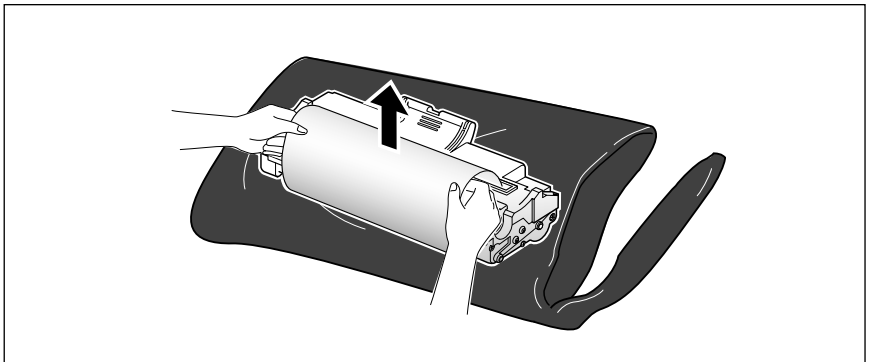

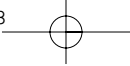

4. Shake the cartridge from side to side 5 or 6 times to distribute the toner evenly inside the cartridge.

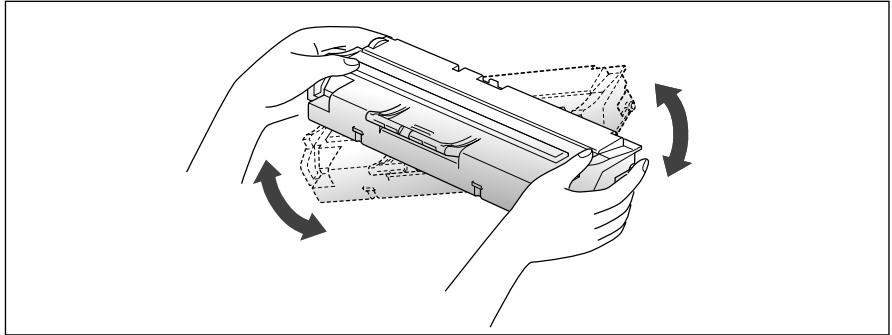

5. Find the cartridge slots inside the machine, one on each side. Grasp the handle and slide the cartridge down between the cartridge slots until it drops into place.

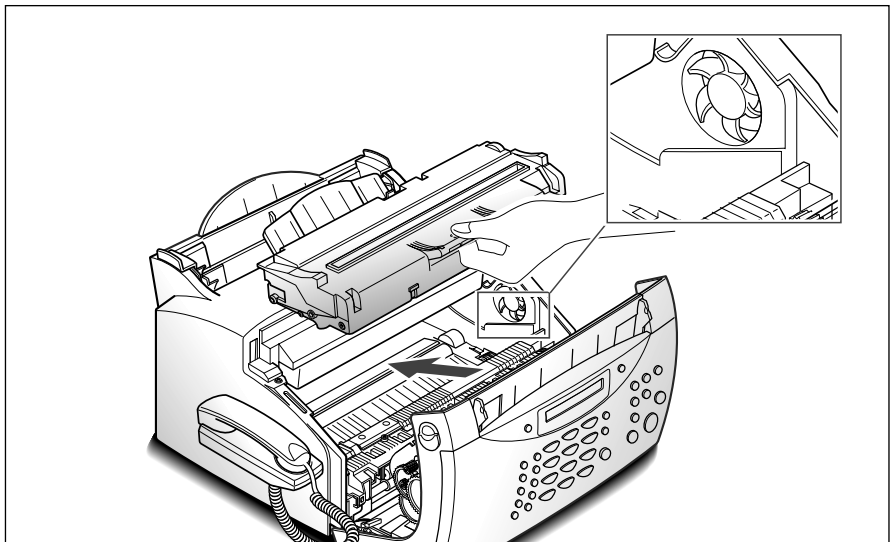

6. Close the cover firmly.

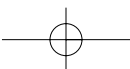
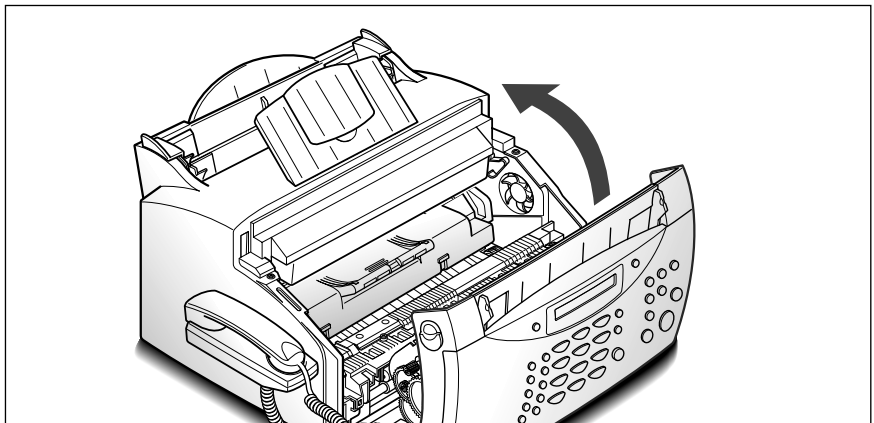

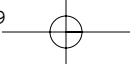

MEMO

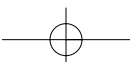

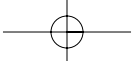

Appendix



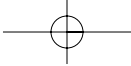

FCC regulations

This equipment has been tested and found to comply with the limits for a Class B digital device, pursuant to Part 15 of the FCC Rules. These limits are designed to provide reasonable protection against harmful interference in a residential installation. This equipment generates, uses, and can radiate radio frequency energy and, if not installed and used in accordance with the instructions, may cause harmful interference to radio communications. However, there is no guarantee that interference will not occur in a particular installation. If this equipment does cause harmful interference to radio or television reception, which can be determined by turning the equipment off and on, the user is encouraged to try to correct the interference by one or more of the following measures:

- Reorient or relocate the receiving antenna.
- Increase the separation between the equipment and the receiver.
- Connect the equipment into an outlet on a circuit different from that to which the receiver is connected.
- Consult the dealer or an experienced radio/TV technician for help.

Do not make any changes or modifications to the equipment unless specified in the manual. If such changes or modifications should be made, you could be required to stop operating the equipment.

Use of a shielded cable is required to comply with Class B limits in Subpart of Part 15 of FCC Rules.

Canadian radio interference regulations

This digital apparatus does not exceed the Class B limits for radio noise emissions from digital apparatus as set out in the interference-causing equipment standard entitled "Digital Apparatus", ICES-003 of the Industry and Science Canada.

Cet appareil numérique respecte les limites de bruits radioélectriques applicables aux appareils numériques de Classe B prescrites dans la norme sur le matériel brouilleur: "Appareils Numériques", NMB-003 édictée par Industrie et Sciences Canada.

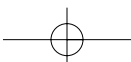

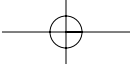

FCC DECLARATION OF CONFORMITY

according to FCC Part 15

1. **Product Name** : Laser Facsimile, Printer, Scanner, PC-FAX
2. **Model Number** : SF-5100, SF-5100P, Msys 5100, Msys 5100P
3. **FCC Rules** : TESTED TO COMPLY WITH FCC PART 15 CLASS B
4. **Operating Environment** : FOR HOME OR OFFICE USE
5. **FCC Compliance Statement**

This device complies with Part 15 FCC rules. Operating is subject to the following two conditions : (1)This device may not cause harmful interference, and
(2)This device must accept any interference received, including interference that can any cause undesired operation.

6. Information to User

This device has been tested and found to comply with the limits for a Class B digital device, pursuant to Part 15 of the FCC rules. These limits are designed to provide reasonable protection against harmful interference in a residential installation. This equipment generates, uses and can radiate radio frequency energy and, if not installed and used in accordance with the instructions, may cause harmful interference to radio communications. However, there is no guarantee that interference will not occur in a particular installation. If this equipment does cause harmful interference to radio or television reception, which can be determined by turning the equipment off and on, the user is encouraged to try to correct the interference by one or more of the following measures:

1. Reorient or relocate the receiving antenna.
2. Increase the separation between the equipment and receiver.
3. Connect the equipment into an outlet on a circuit different from that to which the receiver is connected.
4. Consult the dealer or an experienced radio/TV technician for help.

CAUTION : Changes or modifications not expressly approved by the manufacturer responsible for compliance could void the user's authority to operate the equipment.

Party Responsible for Product Compliance

Samsung Electronics America
American QA Lab
85 West Tasman Dr.
San Jose, CA 95134

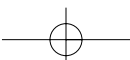

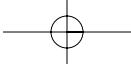

Laser safety statement

The facsimile is certified in the U.S to conform to the requirements of DHHS 21 CFR Subchapter J for Class I(1) laser products, and certified elsewhere as a Class I laser product conforming to the requirements of IEC 825.

Class I laser products are not considered to be hazardous. The laser system and facsimile are designed so there is never any human access to laser radiation above a Class I level during normal operation, user maintenance, or prescribed service conditions.

WARNING Never operate or service the facsimile with the protective cover removed from the Laser/Scanner assembly. The reflected beam, although invisible, can cause eye damage.



CAUTION - INVISIBLE LASER RADIATION WHEN THIS COVER IS OPEN.
DO NOT OPEN THIS COVER.

VORSICHT - UNSICHTBARE LASERSTRAHLUNG, WENN ABDECKUNG
GEÖFFNET. NICHT DEM STRAHL AUSSETZEN.

ATTENTION - RAYONNEMENT LASER INVISIBLE EN CAS D'OUVERTURE.
EXPOSITION DANGEREUSE AU FAISCEAU.

ATTENZIONE - RADIAZIONE LASER INVISIBLE IN CASO DI APERTURA.
EVITARE L'ESPOSIZIONE AL FASCIO.

PRECAUCION - RADIACION LASER IVISIBLE CUANDO SE ABRE. EVITAR EXPONERSE
AL RAYO.

ADVARSEL - USYNLIG LASERSTRÅLNING VED ÅNING NÅR SIKKERHEDSBRYDERE
ER UDE AF FUNKTION. UNDGÅ UDSAETTEELSE FOR STRÅLNING.

ADVARSEL - USYNLIG LASERSTRÅLNING NÅR DEKSEL ÅPNES. STIRR IKKE INN I
STRÅLEN. UNNGÅ EKSPONERING FOR STRÅLEN.

VARNING - OSYNLIG LASERSTRÅLNING NÅR DENNA DEL ÄR ÖPPAND OCH
SPÄRREN ÄR URKOPPLAD. BETRAKTA EJ STRÅLEN STRÅLEN ÄR
FARLIG.

VARO - AVATTAESSA JA SUOJALUKITUS OHITETTAESSA OLET ALTTIINA
NÄKYMÄTTÖMÄLLE LASER SÄTEILYLLE ÄLÄ KATSO SÄTEESEEN.

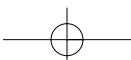

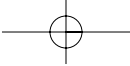

Laser product labels are located above the print cartridge.

CLASS 1 LASER PRODUCT
LASER KLASSE 1
LUOKAN 1 LASERLAITE
APPAREIL À LASER DE CLASSE 1
TO IEC 825

Safety information

PRODUCT SAFETY

USA	UL 1950 (UL LISTING)
CANADA	CSA C22.2 No.950 & UL 1950 (CSA Certification)
EEC (EUROPE)	IEC 60950/EN60950 (TUV GS Certification)
CB	IEC 60950

LASER SAFETY

EEC (EUROPE)	HD 194. & EN 60825
USA	21 CFR, Chapter 1, Subchapter J (CDRH Certified)

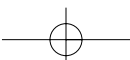

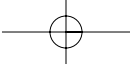

Power saver

This facsimile contains advanced energy conservation technology that reduces power consumption when it is not in active use.

When the facsimile does not receive data for an extended period of time, power consumption is automatically lowered. For potentially faster printing of the first page, you may turn the power save feature off in system data.



The Energy star emblem does not represent EPA endorsement of any product or service.

The equipment has been approved to [Commission Decision "CTR 21"] for pan-European single terminal connection to the Public Switched Telephone Network (PSTN). However, due to differences between the individual PSTNs provided in different countries the approval does not, of itself, give an unconditional assurance of successful operation on every PSTN network termination point.

In the event of problems, you should contact your equipment supplier in the first instance.

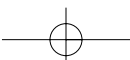

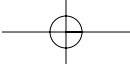

Specifications

Applicable line	Public Switched Telephone Network (PSTN) or behind PABX
Compatibility	ITU-T Group3, ECM
Data coding	MH/MR/MMR (ECM Mode)
Modem speed	14400/12000/9600/7200/4800/2400 bps
Transmission speed	Approx. 6 sec. (V.17 ECM: 14.4 kbps)
Effective scanning width	8.3 inches (210 mm)
Effective printing width	Letter: 8.2 inches A4: 202 mm
Scanning method	Sheet-fed Contact Image Sensor (CIS)
Memory	About 2 MBytes
Halftone	64 levels
Printing speed	6 PPM
Automatic document feeder	20 pages (20 lb or 75 g/m ²)
LCD	16 characters × 1 line
Dimension (W × D × H)	313 × 325 × 228 mm (without handset)
Weight	7 Kg (with accessories)
Power requirements	110 VAC, 50 ~ 60 Hz
Power consumption	(Standby) 70 W (Maximum) 490 W
Environmental conditions	Temperature : 50°F to 89°F (10°C to 32°C) Humidity : 20% to 85% RH
Auto dialer	One-touch dialing (registration for 10 numbers) Speed dialing (registration for 80 numbers)
Document size – Width – Length	5.8 to 8.5 inches (148 to 216 mm) Single page : 5 to 14 inches (128 to 356 mm) Multi pages : 5 to 11.7 inches (128 to 297 mm)
Recording paper size – for automatic feeder	Letter : 8.5 × 11 inches (216 × 279 mm) A4 : 8.3 × 11.6 inches (210 × 297 mm) Legal : 8.5 × 14.0 inches (216 × 356 mm)
– for manual feeder (For SF-5100P only)	min. : 4.5 × 9 inches (100 × 149 mm) (weight : 60 to 130 g/m ²)
Recording paper capacity	150 sheets (weight: 76 g/m ² , thickness: 0.1 mm)
Printing method	Laser Scanning Unit
Scanning density – Horizontal – Vertical	200 dpi Standard : 3.85 lines/mm (98 Lpi) Fine : 7.7 lines/mm (196 Lpi) Super fine : 11.8 lines/mm (300Lpi)
Toner cartridge life - Initial - Running	1000 sheets @ 5% coverage (A4, Basic data) 2500 sheets @ 5% coverage (A4, Basic data) 3000 sheets @ 4% coverage (A4, Calculated data)
Package Weight	Paper : 1,5 Kg Plastic : 0,3 Kg

7.6 Appendix

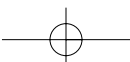

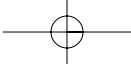

Index

A

- adding documents • 4.7
- alarm volume, setup • 2.8
- auto reduction • 5.4
- automatic dialing • 3.14
- automatic redial • 3.5

B

- broadcasting • 4.1

C

- call back message • 5.1
- caller ID • 5.5
- canceling schedules • 4.7
- cartridge (see toner cartridge)
- connection
 - extension phone • 1.7
 - telephone line • 1.6
 - power cord • 1.7
- contrast
 - button, location • 2.2
 - setting • 3.2
- control panel • 2.2
- copy • 3.10

D

- delayed fax • 4.2
- demo page, printing • 1.14
- discard size • 5.4
- document
 - jam, clearing • 6.1
 - loading • 3.3
 - preparing • 3.1
- document exit tray, setup • 1.5
- document tray, setup • 1.4
- DRPD • 5.6
- dual job status • 3.13

E

- editing
 - group dial number • 5.8
 - number or name • 2.5
 - one-touch dial number • 3.15
 - speed dial number • 3.17
- error message • 6.5
- extension phone
 - connection • 1.7
 - receiving • 3.9

F

- fax
 - reception mode • 3.6
 - paper size • 5.3
 - problems • 6.7
 - receiving • 3.6
 - sending • 3.1

G

- group dial
 - editing • 5.8
 - sending • 5.8
 - storing • 5.7

H

- handset, setup • 1.5
- help list • 5.1

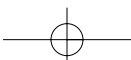

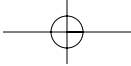
**J**

- jam, clearing
 - document • 6.1
 - paper • 6.2
- journal, print • 5.1
- junk fax barrier • 5.5

K

- key volume, setup • 2.8

L

- language, select • 5.3
- list, print • 5.1
- LCD, location • 2.1
- loading
 - paper • 1.10
 - document • 3.3

M

- maintenance
 - adjust shading • 6.10
 - clean drum • 6.9
 - remote test • 6.10
 - notify toner low • 6.11
- memory, clearing • 5.9
- multi-communication report • 5.1

N

- name, setting • 2.6
- number
 - fax, setting • 2.6
 - group dial • 5.7
 - keypad, using • 2.3
 - one-touch dial • 3.14
 - speed dial • 3.16

O

- one-touch dial
 - editing • 3.15
 - sending • 3.15
 - storing • 3.14
- opc drum, cleaning • 6.9

P

- paper
 - jam, clearing • 6.2
 - loading • 1.10
 - size, setting • 5.3
 - type and size • 1.12
- pause • 2.5
- phonebook list • 5.1
- polling
 - receiving • 4.6
 - sending • 4.5
- power cord, connection • 1.7
- power failure report • 5.1
- power save mode • 5.3
- priority fax • 4.4

R

- recall • 3.13
- received journal • 5.1
- receiving
 - in ans/fax mode • 3.8
 - in auto mode • 3.8
 - in fax mode • 3.7
 - in tel mode • 3.7
 - polling • 4.5
 - using extension phone • 3.9
- reception modes • 3.6
- redial • 3.12
- report, printing • 5.2
- resolution
 - button, location • 2.1
 - setting • 3.2
- ringer volume, adjusting • 2.8

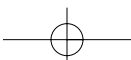

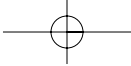
**S**

- schedule information • 5.1
- searching
 - memory • 3.18
 - redial memory • 3.12
- sending
 - after talking • 3.4
 - automatically • 3.4
 - broadcasting • 4.1
 - delayed fax • 4.2
 - priority fax • 4.4
 - polling • 4.5
- sending confirmation • 5.1
- sent journal • 5.1
- setup
 - document tray • 1.4
 - document exit tray • 1.5
 - handset • 1.5
 - system • 5.2
- shading, adjust • 6.10
- speaker volume, adjusting • 2.8
- speed dial
 - editing • 3.17
 - sending • 3.17
 - storing • 3.16
- system data list • 5.1
- system setup
 - auto reduction • 5.4
 - caller ID • 5.5
 - discard size • 5.4
 - distinctive ring pattern detection • 5.6
 - ECM mode • 5.5
 - fax paper size • 5.3
 - language • 5.3
 - power save mode • 5.3
 - RCV. start code • 5.5

- rings to answer • 5.4
- send from memory • 5.3
- sending confirm • 5.3
- stamp RCV. name • 5.4
- toner save mode • 5.3

T

- TAM cord, connection • 1.7
- telephone line, connection • 1.6
- time and date, setting • 2.7
- toner cartridge
 - installing • 1.8
 - replacing • 6.14
- toner save mode • 5.3

U

- unpacking • 1.1

V

- voice request • 3.5
- volume, adjusting
 - alarm • 2.8
 - key • 2.8
 - ringer • 2.8
 - speaker • 2.8

